

Sustainable Nutrition Manual

Food, Water, Agriculture & Environment

Part 1 Healthy Humans



wfp.org

Supported by
World Food Programme

Sustainable Nutrition Manual, 2nd Edition (2016)



Endorsed by Malawi's
Ministry of Agriculture, Irrigation and Water Development
Agricultural Technology Clearing Committee
2016 February 27th.

First published by World Food Programme (WFP) Malawi as:
Low Input Food and Nutrition Security: Growing and Eating More for Less (2005)

Additional electronic copies are available from:

Ministry of Agriculture, Irrigation and Water Development

Department of Agricultural Extension Services (DAES), Nutrition Unit
PO Box 594, Lilongwe, Malawi
Agricultural Communication Branch
Phone: +265 (0) 1-751-221
Email: AgricNutrition@gmail.com

World Food Programme Malawi

Post Office Box 30571, Lilongwe, Malawi
Phone: (+265) (0) 1-774-666, fax: (+265) (0) 1-773-785
Website: <http://www.wfp.org/countries/malawi>
E-mail: wfp.lilongwe@wfp.org
Facebook: www.facebook.com/wfpmalawi1
Twitter: [WFP_Africa](https://twitter.com/WFP_Africa)

NeverEndingFood

Post Dot Net, x-124 Crossroads, Lilongwe, Malawi
Website: www.NeverEndingFood.org/Sustainable-Nutrition-Manual
Facebook: <https://www.facebook.com/nordinmalawi>
Twitter: <https://twitter.com/NeverEndingFood>

Creative Commons

You are welcome to copy and share this manual in any form.
Please acknowledge the source when sharing any part of it, using this citation:
Nordin, Stacia. *Sustainable Nutrition Manual: Food, Water, Agriculture & Environment*.
2nd ed. Ed. Sarah Beare. Lilongwe: World Food Programme Malawi, 2016.

Table of Contents

USING THIS MANUAL	III
Thinking Differently!	iii
What is Needed for Sustainable Nutrition?	iv
Pyramid of Nutrition Needs	v
Three Parts to the Manual	vi
PART 1 HEALTHY HUMANS	1
TOPIC 1: FOOD AND NUTRITION	2
What is Good Nutrition?	2
The Human Digestive System	2
Digestion and the Nature Cycle	3
Different Classes of Nutrients	4
The Nutrient Village.....	4
TOPIC 2: THE IMPACT OF FOOD CHOICES	6
The Current Meal	6
The Cycle of Dependency.....	7
The Better Meal.....	11
The Cycle of Better Living.....	12
TOPIC 3: MALAWI'S SIX FOOD GROUPS	15
The Malawi Food Groups Circle	15
Fats and Oils	16
Animal Foods	16
Legumes and Nuts	16
Vegetables	17
Fruits	17
Staples	17
Water.....	17
Eating a Balanced Diet	19
TOPIC 4: FOOD SECURITY	20
Foods Available Seasonally	20
Local Foods in Malawi	21
Restoring Biodiversity	23
TOPIC 5: PLANNING FOOD AMOUNTS	25
Estimating Food Measurements	25
Guide to a Balanced Diet	27
How Much Food Should You Save?	31
Planning Food for Larger Numbers	32
TOPIC 6: HEALTHY BODY WEIGHTS	33
The Body Mass Index (BMI)	33
Maintaining a Healthy Weight	34
Tips for Losing Weight	36
Tips for Gaining Weight	37
Nutrient-rich Meals for Low Appetites.....	38
Summary Charts for Gaining or Losing Weight	38

TOPIC 7: HEALTHY EATING HABITS	41
Questions and Fears about Food Changes	42
TOPIC 8: PROTECTING NUTRIENTS	44
Conserving Nutrients in Food	45
TOPIC 9: FOOD HYGIENE AND SAFETY	47
Germs.....	47
Personal Hygiene.....	48
Food Safety.....	49
TOPIC 10: WATER PURIFICATION AND STORAGE	53
Methods for Safer Drinking Water	53
Sedimentation of Your Water.....	53
Filter your Water.....	54
Disinfect your Water.....	56
Store Water Safely	57
TOPIC 11: KITCHEN AND DINING SPACES	58
TOPIC 12: ENERGY USE IN THE KITCHEN	61
Three Stone Fires	62
Energy-efficient Cooking.....	62
Fuel-efficient Wood Stoves	63
Paper Charcoal “Briquettes”	64
Insulated Basket Cookers / Coolers	66
Solar Cookers	67
Bio-gas Systems	70
TOPIC 13: FOOD PRESERVATION AND STORAGE	72
Storing Foods in the Environment	72
Preserving Foods for Future Use.....	72
Short Term Storage.....	73
Long Term Storage	74
TOPIC 14: CREATIVE COOKING	78
Recipes for Each Food Group	79
Staple Food Recipes.....	80
Fruit Recipes.....	84
Vegetable Recipes	87
Legumes & Nut recipes.....	91
Animal Food Recipes.....	93
Fats and Oils Recipes.....	96
POSTERS TO COPY AND DISPLAY	97
GLOSSARY FOR PART 1	114

Using this Manual

Thinking Differently!

This manual is for people who eat, grow or buy food and who want to improve their own lives, their community and the environment that they live in. It has been written for, and by, people living in Malawi, but the ideas in it can be applied anywhere in the world. It is for all people, everywhere, but most of all it is for you. Many people in Malawi have used this manual with great results and, if you use these ideas, you will also be able to:

- Improve your diet and health
- Save money that was spent on food, medicines and chemicals
- Double or triple yields and harvests (or even more!)
- Reduce the amount of watering in gardens and orchards
- Reduce the amount of work done on your land and in your home
- Have healthier plants and animals
- Reduce infertile and unproductive areas of land
- Use free resources to improve soil and water in your area

The manual aims to show you that, by thinking differently and thinking sustainably, you can improve your health, diet, lifestyle and surroundings easily and cheaply. Even if most of your food is bought, it shows new ways to think about, source and use food.

The book will put these ideas into the context of caring for the environment (which is the source of all our food) by using Permaculture Principles and sustainable farming techniques.

You will gain an understanding of the term Sustainable Nutrition by learning first about nutrition and what your body needs to have a healthy, varied, diet and a healthy living environment. Then you will learn how to get this healthy diet onto your plates.

When you understand what your body needs for health then you will learn that the natural environment needs diversity to stay healthy too. The health of your body and the health of the environment where food is grown are closely linked.

What you learn about Sustainable Systems in Nature and different kinds of resources will guide you into the creation of a Personalised Design for you and your family to achieve Sustainable Nutrition.

Your children will learn healthy habits as they grow, and, by working with your neighbours and community groups, life will improve for everyone in Malawi, now and into the future, forever. By increasing understanding, sharing ideas and working with Nature everybody can achieve what they need for sustainable nutrition and healthier, happier lives.

What is Needed for Sustainable Nutrition?

Sustainable Nutrition means having a permanent diet of good, healthy food and water, combined with healthy living conditions. If something is sustainable it means it can keep going, it can be sustained.

So to have Sustainable Nutrition we need to look first at ourselves, our diet (what we eat and drink), and how we live. Then we look at our communities and how we use our resources. We need to look after our environment and make sure it is healthy, because without a healthy environment we cannot grow what we need to eat or have the water, air and energy we need to be healthy.

All of the subjects listed below will be covered in detail in the manual and you will begin to understand why each one is important if Sustainable Nutrition is to be achieved.

Nutrition

This means eating a varied diet of foods, drinking adequate clean water and living a healthy lifestyle. We will start close and personal by looking at our own bodies, how we digest food and what we need to be healthy, energetic and strong.

Healthy Living Conditions

A healthy body and healthy living conditions means that our body can use the nutrients from food and water properly. This means we must take good care of our bodies and our surroundings, and we must also have good hygiene practices. Adequate water is needed for sanitation and hygiene as well as drinking and cooking.

Food and Water Security

To have food security we need to have a wide range of foods from all 6 food groups every day. Clean water needs to be available every day, too. These resources must be used wisely and people must plan for the future in addition to our immediate needs.

Healthy Human Systems

As members of our communities and organisations we need to encourage good policies for education, agriculture, health, the economy, transport, energy and industry. Human Systems need to protect and conserve the Natural Systems of the environment.

Healthy Natural Systems

The Nature Cycle, which is the source of all our sustainability, must be healthy if it is to provide what we need. We need to care for the soil and keep it fertile. Poor, degraded soil must be repaired and improved. We need to understand the Water Cycle, and why it is important to conserve water and use it wisely. We need to encourage variety and diversity of plant and animal life in all environments. All our resources must be used wisely if they are to go on sustaining us.

Pyramid of Nutrition Needs

The ideas listed above can be summarised as a pyramid that demonstrates what is needed for a good strong foundation for Sustainable Nutrition.

Nutrition starts with our natural systems as the basis of everything in the world. Communities build systems and manage resources that either provides us what we need sustainably, or not. If the base of the pyramid is strong, the need for chemicals and medicinal treatments are reduced, and even eliminated.

If we achieve food, water and health security, then the result, the top of the pyramid is good nutrition. If we fail, the result is poor nutrition.

These terms will be covered in Topic 1 Food and Nutrition.

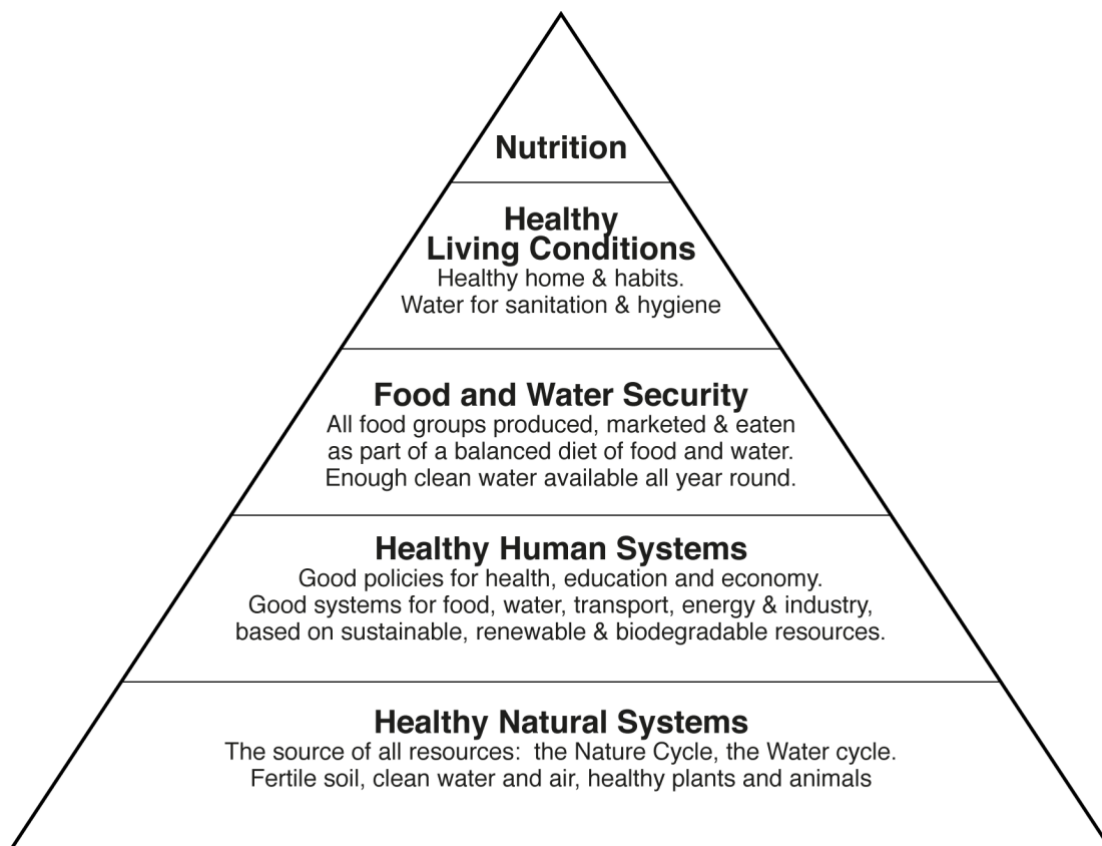

Each topic in the manual falls into one or more of these categories and we will refer to this Pyramid of Nutrition Needs frequently throughout. We will be looking closely at each of the topics in this diagram to see how they affect your life and what you can do to improve each of them for yourself, your community, your nation and your world.

When all of these things are in place and working well Sustainable Nutrition will be within your reach.

Three Parts to the Manual

The manual is written as three books, each covering a different subject. The subjects are presented logically but you can look things up in any order by using the contents pages and the index. You can dip in and out, and get to know the manual. There is a lot of very useful information in here to help you achieve Sustainable Nutrition!

Part 1 *Healthy Humans*

This first book is about the Human Body and Nutrition. You will learn about the food choices we make and the benefits of Diversity in diet. You will learn about how these choices affect your health and other areas of life. This book can be used in any kitchen and around the home, school or other institution. It has lots of useful ideas to improve life and many delicious recipes and suggestions for tasty, healthy meals and snacks. At the back of this book there are also 15 posters. Copy them and put them on the wall to remind you to think about the issues and to share your learning with others.

Part 2 *Healthy Environments*

The second book is about Natural Systems and Sustainability. You will learn about the Nature Cycle and the Water Cycle. You will be introduced to Permaculture ideas and sustainable food production practices. Understanding Soil Fertility and the benefits of Diversity in Nature will develop. You will find out about renewable and non-renewable resources and begin to understand the wider issues of sustainability. This book can be used in your homes and gardens, orchards and farms, and you will be discussing the ideas in it with others.

Part 3 *Healthy Designs*

The third book is about designing for Sustainable Living. This book brings parts 1 and 2 together and guides you to use your knowledge and ideas to make a personalised plan for achieving Sustainable Nutrition. This book is a really practical one to use in the gardens and fields. There is lots of information in the appendices about foods of Malawi and other resources that will be useful as your design for Sustainable Nutrition develops.



Each book will ask a lot of questions to encourage you to observe, think and discuss. The things you need most are free: creativity, intelligence and an open mind.



Keep a notebook from the beginning. Write down what you discover when you do the activities suggested. Draw and write your own ideas. There are some blank pages in each book to get you started.

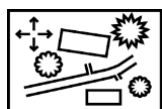

You will draw simple maps of your area and will add information to this as you read the manual. All this information will be used to create your design for Sustainable Nutrition in Part 3 of the manual.

Part 1 Healthy Humans

This first book is about the Human Body and Nutrition. You will learn about the food choices we make and the benefits of diversity in diet. You will learn about how these choices affect your health and other areas of life. This book is to be used in any kitchen and round the home or school or other institution. It has lots of useful ideas to improve life and many delicious recipes and suggestions for tasty, healthy meals and snacks. At the back of this book there are also 15 posters. Copy them and put them on the wall to remind you to think about the issues and to share your learning with others.

Topic 1: Food and Nutrition

Foods and drinks provide us with our **nutrients**, which our bodies must have to live and to run the best they can. The human body can survive on unhealthy food and drink for quite a long time, but it will not thrive or be as healthy as it could be.

When we eat and drink the right nutrients, we are stronger, more energetic, healthier, happier, and more productive. You will find out in this manual that these healthier food choices are also better for our environment.

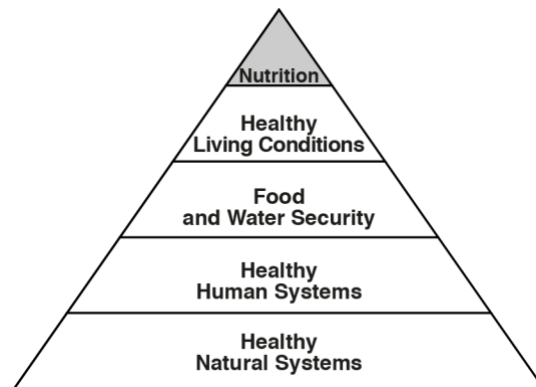

What is Good Nutrition?

“**Good Nutrition**” means that the foods and drinks you eat provide your body with all the nutrients you need, and that your body is able to use those nutrients well for health, growth and energy.

“**Poor Nutrition**” means that the foods and drinks consumed are not giving you enough nutrients, and / or that your body cannot use the nutrients, perhaps because of an illness or other health problem.

All living things have their own nutrient needs and each living thing gets the nutrients it needs from other parts of nature. Animals get their nutrients from either: plants (herbivores), other animals (carnivores), or both (omnivores).

Humans are mostly omnivores, but many humans are herbivores (vegetarians). Plants get their nutrients from the soil, from the plants and animals that lived, died and decomposed in the ground. It is very important that our soil is well fed so that it contains the nutrients it needs to stay fertile so it can feed everything else. We will learn more about this in Part 2, Healthy Environments.

The Human Digestive System

Before our body can use food and drink it must break down the food into smaller parts, which are the nutrients. These nutrients are small enough to be absorbed into our bodies in a process is called digestion.

A strong and healthy digestive system breaks food down easily into nutrients and these are absorbed well. The digestive system also prevents harmful germs from getting into the blood and making us ill.

With a weak digestive system foods are not broken down well, the nutrients are not absorbed well and the digestive system allows harmful germs to enter into the blood.

Mouth

Digestion starts in the mouth when we chew. Your teeth chop food into small pieces and mix it with saliva (the juices in your mouth) so that it is easy to swallow. If we chew well, the rest of the digestive process is easier.

Oesophagus

After chewing we swallow. The food goes down a tube called the oesophagus, to the stomach. It does not “fall” down but is squeezed down to the stomach.

Stomach

The stomach is a bag inside you, which makes special liquids, with chemicals called enzymes. These break the food down into even smaller parts, which are the nutrients.

Intestines

The intestines are a very long tube low down in your belly. Intestines are folded up inside you and as the nutrients move slowly along they enter through the walls of the intestines and into your body. This process is absorption. Once nutrients are in your body and your blood they can give you energy, protect you from illness and help you grow or heal yourself.

Anus

There are some parts of the food that do not go through the wall of the intestines. Some of these things were important to help the body digest the food but it does not need to keep them. These get pushed out of the anus (your bottom), when you go to the toilet. This ‘waste’ from the body should be returned to the soil. Manure is food the soil needs to stay fertile so it can grow more food in future.

Blood

After digestion the nutrients go into the blood, which carries them to where they are needed in the body. The body can store some nutrients, if they are not needed immediately, but not all of them. You will learn more about this in the next few pages.

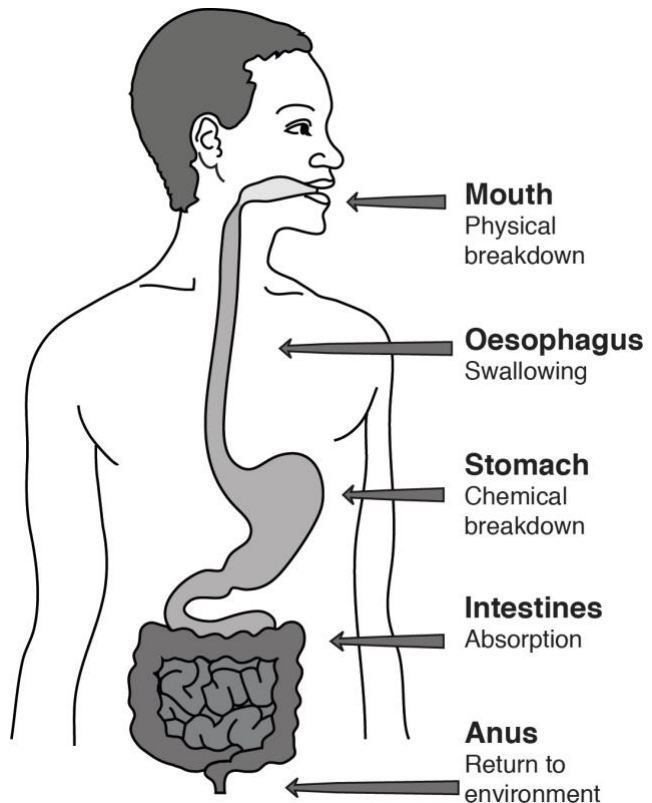

Digestion and the Nature Cycle

Processes very like these happen in the natural world and are a vital part of all life on Earth. The food for everything that lives comes from the bodies of dead plants and animals, from fur and feathers, fallen leaves, dried plant matter, and from manure rotting down, de-composing and being returned to the soil. We call this the Nature Cycle and we will find out more about how nature re-uses all this kind of natural organic matter in Part 2 of the Manual.

- The “food” of the soil is the bodies and manure of plants and animals that have lived and died on the Earth.
- The “chewing” is done by animals, insects, sun and water. These break the plant and animal matter down into smaller pieces
- The “stomach” are the micro-organisms in the soil. The small parts of dead plants and animals mixes with tiny micro-organisms a bit like the enzymes in our stomachs. These make the nutrients small enough for the soil to absorb
- The “intestines” are the plants’ roots, absorbing the nutrients. Plants use the nutrients, just like our body does, for growth, energy and health

After growth, then the plants become food again for other living things, which live and die and return to the soil, as everything does. This cycle goes on and on. It is sustainable because it can keep going forever.

Different Classes of Nutrients

There are about 100 nutrients that the human body must have to sustain life. About 50 of the nutrients are essential, meaning we have to get them from foods and drinks because our bodies cannot make them.

Our bodies can make the other 50 nutrients if we eat the essential ones. Eating a wide variety of foods and drinks can provide all the nutrients that we need. All the nutrients work together helping us grow and mend ourselves, giving us the energy we need to live, work and play and they help with protecting our health and fighting off illnesses.

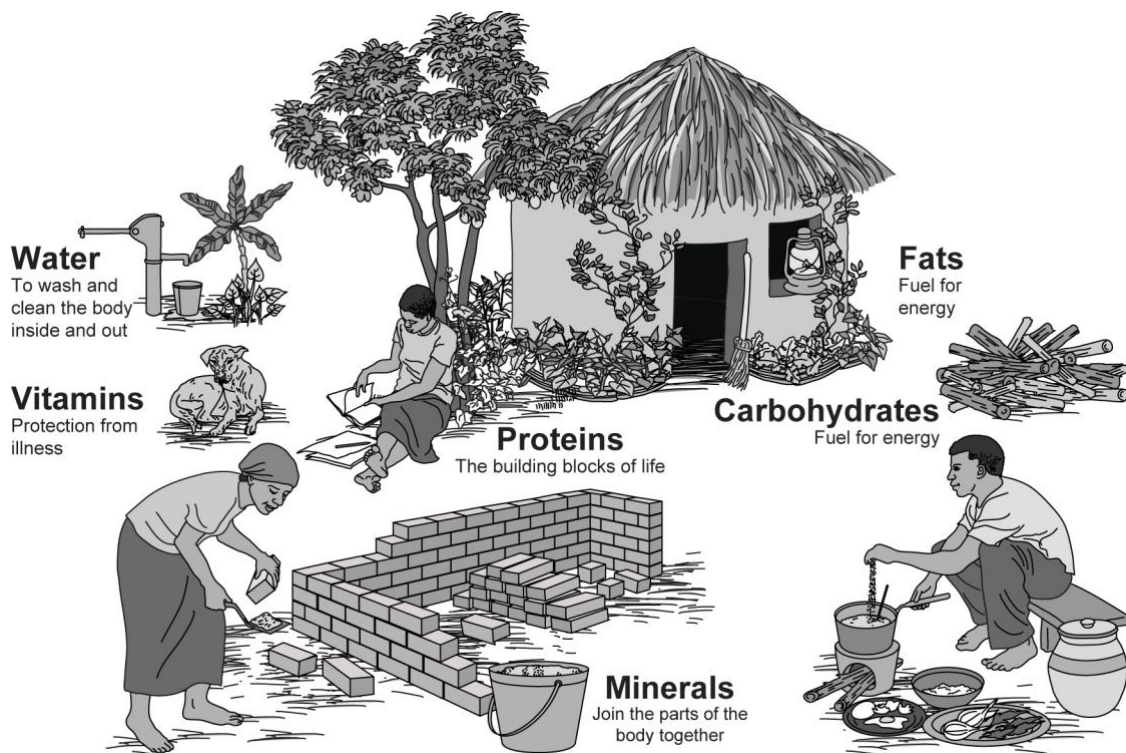

The Nutrient Village

Nutrients are grouped into 6 classes that do different jobs in the human body. Think of the different things that you need to build a house and how these things work together to make a good home. The nutrients from our food and water are like this, working together, to keep us healthy.

Proteins - A house is built with bricks and our bodies use protein to build in a similar way. Our bones, muscles, skin and hair are built from the proteins that we eat. We need 8 types of protein and babies need one more protein, which they get from breast milk.

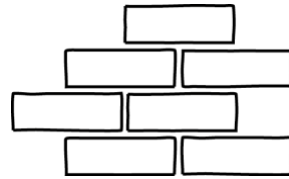

Minerals - The bricks of a home are joined together with mortar. Similarly, different parts of our bodies are joined with minerals. Calcium in our bones and teeth makes them strong and iron in our blood joins to the protein to carry oxygen. There are at least 15 different essential minerals.

Carbohydrates - In Malawi we burn firewood for cooking and heating energy. The fuel our bodies need to give us energy are carbohydrates. There are 2 energy-giving carbohydrates called starches and sugars. Another type is fibre, which does not give energy but cleans the intestines during the digestive process. Fibre works like a broom and needs water to work best. Fibre is found only in plant foods.

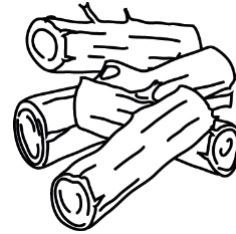

Fats - Another form of energy we keep in our homes is paraffin, which can be stored in a small container. A little bit of paraffin burns for longer than firewood. Similarly, the fats in our body are also burned for energy, but they give more energy than the carbohydrates. Fats are also easier for our bodies to store for later. There are 2 types of fat that we must eat and both come from plant foods. Animal fats are not essential to good nutrition.

Vitamins - Once we have a strong home built with good materials we will want to protect it with a watchdog. Our bodies use vitamins to prevent intruders like germs and infections that cause illness. There are at least 16 different vitamins that we need and Nature also provides many medicinal plants that can prevent and treat disease.

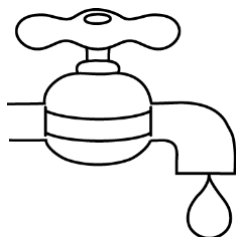

Water - All homes need water for cleaning, cooking, washing and drinking. This is the most important nutrient, as we cannot live for more than a few days without it. Three quarters (75%) of our body is made up of water, the same as our earth. It is the liquid of our blood, carrying the nutrients and oxygen. Water is also used for cleaning jobs in the body. All the water we drink, clean or cook with must be clean.

Topic 2: The Impact of Food Choices

The foods you choose to grow, buy and eat, and how you live your life have a big effect on your health, the environment around you and resources that are available to you.

This subject is number 3 on the Pyramid of Nutrition Needs. Choosing foods that are good for you, starts with what is on your plate.

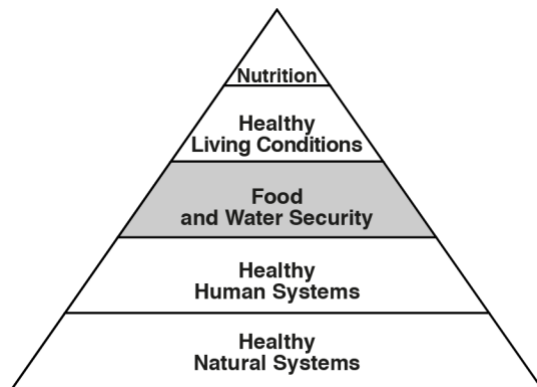

Think about what you eat. What did you eat for your last meal? What about the meal before that? And before that?

Write your answers down in your notebook or on one of the blank sheets in this book. Compare what you ate with what others around you ate.

The Current Meal



Does this plateful look like the meals you eat? If you are a Malawian you probably ate a big pile of *nsima* (from refined maize flour) with a little bit of *ndiwo* - either a side dish of vegetables, beans or an animal food. The staple food takes up more than half of the plate in this meal.

This meal, the current meal, can make you feel full, but there are many problems with it. A big reason for malnutrition in Malawi is that people do not choose foods for growth, energy and health; they choose foods just to make them feel full. Let us look at what is on this plate in detail.

Few nutrients

This food has very few nutrients in it. The serving of maize (or rice, potatoes, yams, etc.) is too large and gives too many carbohydrates. The small helping of *ndiwo* does not provide all the other nutrients you need. Yet this meal is often eaten twice a day, every day. The *ndiwo* is often overcooked green vegetables. This meal does not give all the proteins, fats, vitamins and minerals that your body needs and it will be impossible to stay strong, energetic and healthy.

Mono-culture farming

This plateful, with its big pile of *nsima*, encourages farmers to grow lots of one crop (maize) but not much else (the vegetables for the *ndiwo*). If you eat like this, the environment and markets have to look like this too, with lots of maize and very little of anything else. Growing just one species is known as mono-culture (which means 'one culture'), or a mono-crop (one crop). Natural variety and diversity is cleared to make way for mono-cropped maize. This weakens the healthy Natural systems, which are so important to us all.

High risk of crop failure

Mono-cultures are risky. Insects and diseases love the unbalanced conditions of mono-crops as nothing (predators, other plants and trees) stops them moving from one plant to the next and ruining the whole field. If the weather is unfavourable that year, for your one crop, your yields will be reduced or a complete failure.

Food insecurity

The current meal does not bring food security because eating like this does not give enough variety in the diet. Food security means having a balance of the different foods that we need to be healthy, every day. But if your mono-crop fails and you have grown no other foods that might have done well with that year's weather (or insects or diseases), you will not get all the nutrients you need.

Environmental degradation

Mono-culture farming does not look after the fertility of the soil that grows our food. Growing one crop, over and over again, wears out the soil and encourages pests and disease. In addition, other activities that people use produce food are also harmful. Slash-and-burn agriculture poisons the air and takes nutrients away from the soil. The soil becomes less fertile and does not hold water so well, which makes it hard for plants to grow.

High input dependency

This environmental destruction and poor human health leads to people depending on high inputs. These are hard work, seeds, chemical fertilizers and pesticides that have to be bought with money.

The Cycle of Dependency

The Current Meal results in dependency on high inputs in order to treat symptoms of underlying problems. This 'Cycle of Dependency' started in the 19th Century and has been getting worse ever since, all over Africa and the world, as well as in Malawi. Let us hope that in the 21st Century we can turn this unhealthy situation around by bringing biodiversity back into our environment, our agriculture and our diets!

Let us look at each of the boxes in the diagram below to see how everything connects, and then discuss different ways we can break this destructive cycle.

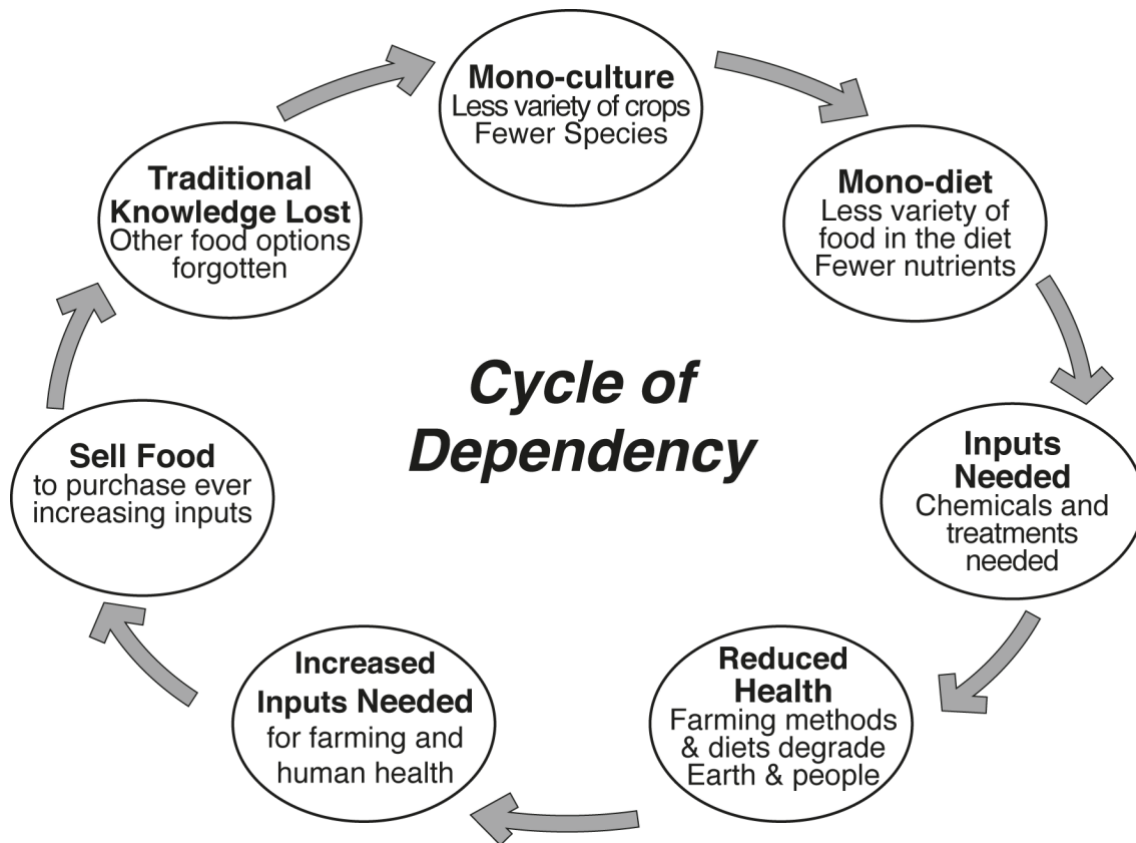

Mono-cultures

In Malawi maize has become a mono-crop, similar to the situation in nations following the path of industrial agriculture. But maize was not always in Malawi; Portuguese traders brought it to Malawi just before 1800. There was a lot of diversity in agriculture and the natural environment in Malawi back then, but people in power promoted maize instead of local, native foods. By the 1940s, maize, and other species introduced by outsiders, were taking over the landscape and diets.

Before maize what did people in Malawi grow?

Malawians were growing, gathering and eating a wide variety of indigenous foods, like millet, sorghum, yams and other tubers, vegetables, fruits, nuts, beans, oil seeds, different kinds of animals and insects. These foods were found at all different times in the year, not just during one harvest month. Ask the elders what foods they ate when they were young, what life was like in the past, and how long people lived. There is a lot of rich Malawian history and culture to learn about. We need to restore this knowledge and use it. It is a vital part of planning for Sustainable Nutrition and improving our health, our lives, our incomes and our environments.

Why did people start growing this new food?

Maize does generally have a higher yield per stem than the indigenous grains. Maize was also seen as a modern food, with a higher status than traditional food plants. But it is a very high-input crop requiring more water, nutrients and care so it takes more effort and money to grow. Eating just one type of food provides fewer nutrients and monocropping of maize (or any crop) contributes to environmental problems. In contrast to maize, sorghum and millet grow well close together in clumps, multiply and spread easily each year. They are well suited to the climate, tolerate different weather or pests better and they provide more types of nutrients in our diets than maize.

Imbalance in Natural Systems

Mono-crops are also found in some vegetable gardens, orchards and with livestock. Chickens, for example, provide an important soil nutrient called nitrogen (which we will look at in more detail in Part 2) from their feathers and manure. But too many chickens in one area can put too much nitrogen in the area, which can harm the soil, air and water and put the chickens at risk for diseases. It is all about finding and maintaining a healthy balance, in the Natural environment, in agriculture and in our diets.

Mono-diet

The food we eat comes from what we grow and, at the moment, we grow a lot of maize and not much else, so that is what our diet looks like too; lots of maize and not much else. In towns people are eating more imported and processed foods but that diet can also be harmful to our health, economy and environment.

Worldwide, we currently grow and use only 30 plants to provide us with 95% of our energy and protein. There is no way this can provide all our nutrients! But this does not have to be the case - in Malawi alone there are about 600 foods to choose from - the diversity is awesome!

Inputs required

Because agriculture and diets are so narrow they do not supply what is needed for growth and the health of the environment or the people. So people start using additional inputs to treat the symptoms that result from the unhealthy systems. They have to buy special seeds that will tolerate the poor environmental conditions, but the seeds cannot be saved. They have to be bought each year. The soil, plants and animals require chemical treatments to keep away pests and diseases, and they need nutrient powders for nourishment.

The mono-diet cannot provide us with all our nutrients so as a result foods get altered either as they grow, or during processing as fortification or sprinkled powdered nutrients before we eat them to give them additional nutrients that could be found naturally in other foods if we just diversified our food; or by taking nutrient supplements in addition to the mono-diet.

All these treatments use lots of human energy, time, money and natural resources. We would not need them if we restore diversity and start using sustainable food and agriculture systems.

Reduced health (people, environment, economy)

The symptoms of environmental degradation get worse each year that mono-cultures and mono-diets continue. These unhealthy practices are combined with slash-and-burn agriculture, soil erosion, water run-off and increases in human populations. The health of our market economy can also get worse.

If everyone depends on just one grain (such as maize, rice, or wheat) and that grain grows poorly, or something happens to the grain stores, there is a lot of competition and prices rise steeply. This can happen at local, national or global scale. The main thing that causes this is that our current systems rely on very few foods, grown by a few farmers and controlled by a very few companies. We need diversity in all systems for strength, productivity and health.

Increased input (people, environment, economy)

As the environment, and peoples' health deteriorates, even more inputs are needed and inputs are needed on a larger scale. Many nations feel they have to fortify selected foods (like wheat, rice, beans, or oil) to add nutrients that are missing from the nation's diet. These subsidy programmes can seem to help for a short time, but they do not look at the causes of the problems, so the problems continue to get worse. All these inputs use lots of human energy, precious natural resources, time and money putting increased pressure on our economy.

Sell food (or other assets)

To get money for additional inputs, people often have to sell their crops and animals. These are the very items that they spent so much time, money and energy to raise! If the unhealthy agricultural practices continue then each year the soil becomes unhealthier so, each year, the farmer has to buy even more inputs. If there is a particularly bad year, the farmer not only sells food, but also other household assets.

Traditions and local knowledge are lost

As the habit of eating maize at every meal continues, knowledge about traditional foods and medicines are forgotten and lost. People do not know about other natural resources growing all around them or how to use them. As people think that there is no value in the plants and animals in the natural areas they clear more and more land, destroying natural diversity and making it harder to find the local foods and medicines even if they do know about them.

This knowledge has taken thousands of years to develop and is as full of value for Malawians today as it has ever been. It is critical that this generation revives this knowledge and puts it to use! We need to turn around the problems with the environment, heal the soil, and build strong and healthy systems for the future.

So things continue to get worse...

People continue to mono-crop maize, use harmful agriculture practices, eat a poor diet, plant in drought and flood prone areas and every year there are the same problems. People have lost knowledge of alternatives to growing and eating maize. They can be stuck in a cycle of dependency, which is negatively affecting their health, the health of the environment, their society, their self-esteem and the economy. We need, instead, to address the causes of the problems together instead of treating the symptoms and continuing to repeat the negative cycle.

Solutions exist!

There is a way out of this high-input, harmful cycle. We can break the Cycle of Dependency as soon as we start caring for our soil, managing our resources, valuing and promoting diversity in our landscape and in our diets, working together and thinking creatively about finding solutions.

The Better Meal



There is a better way to eat and it is easy to have a healthy body, society, environment and agriculture. You just have to begin by making a few changes and using your imagination! The Better Meal has the same amount of food as the “Current Meal”. But the balance and variety of the foods is different. There is a smaller amount of the staple food (nsima, rice, wheat, potato etc.) with a larger portion of relish containing more, different ingredients in it, which means more protein foods and vegetables. There is a piece of fruit and a glass of water. This plateful will still fill you up, but the staple takes up less than half the plate, with lots of different kinds of food on the other half.

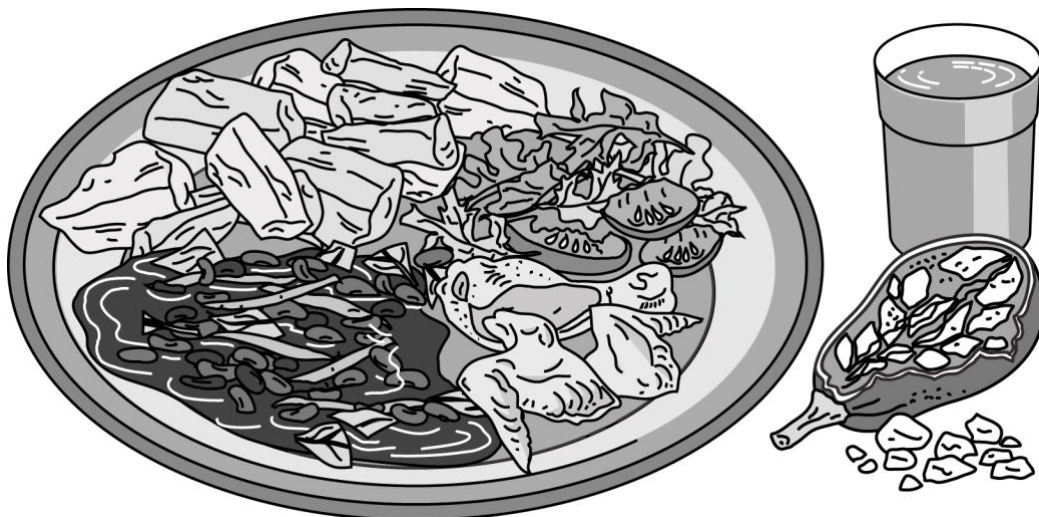

The other difference in these pictures is that the foods change every meal and the plate will look different from one day to another. On this plate there are starchy roots (instead of *nsima*), salad with tomatoes, mixed legume and vegetable relish, a bit of chicken, and a glass of baobab juice.

The staple food of the Better Meal should be millet, sorghum, yam or other tubers or grains, on some days, instead of maize. There are many different foods to choose, to put more diversity onto your plates. We will look at this more when learning about the Six Food Groups, and what is available in Malawi. We will also start preparing some delicious and nutritious recipes.

The Cycle of Better Living

The Better Meal reverses all the problems of the Current Meal. Diverse diets, with balanced food, can provide all the 50 nutrients a person needs. This requires diverse agriculture, and markets, which bring with them an increased chance of harvesting different foods all year through. Even if conditions are poor for a few foods, other foods will do well, increasing food security.

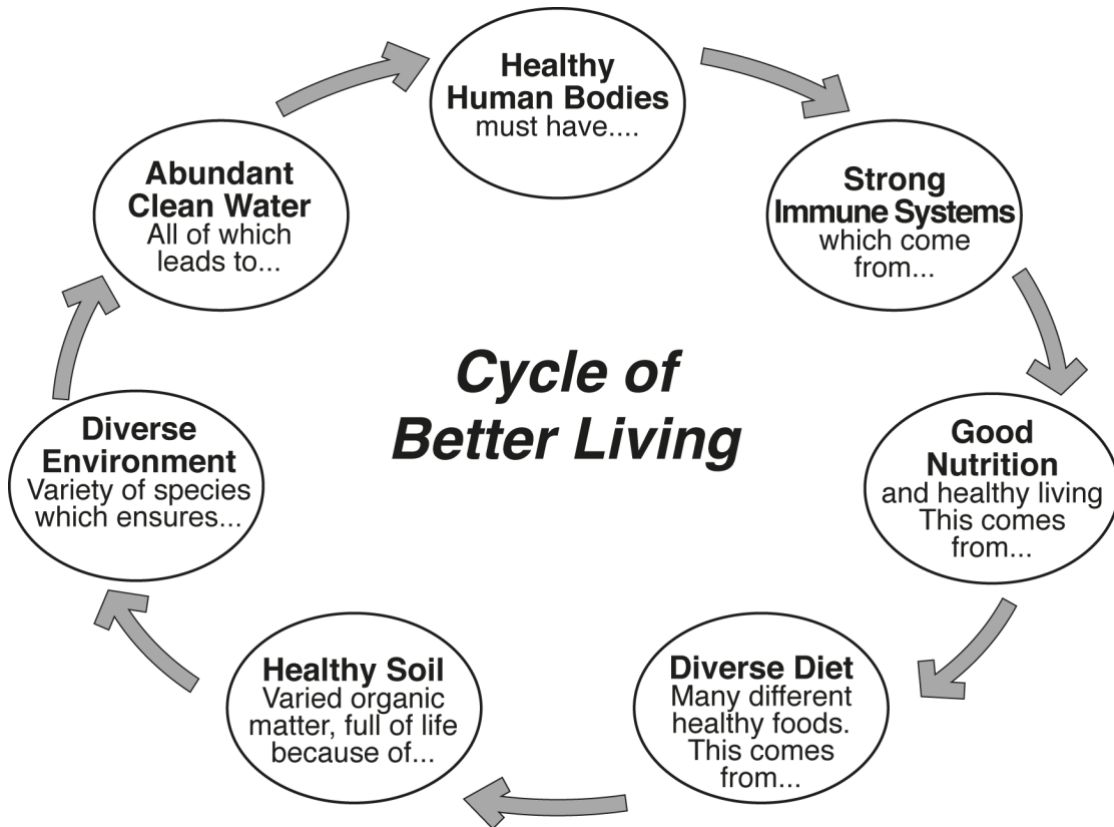

Diversity contributes to a healthy environment. Healthy environments need fewer inputs because there are not so many problems with pests, diseases and poor soil to 'treat'. Other inputs such as labour, money and water also decrease over time as the soil becomes healthy, strong and productive again.

Let us look at each of these subjects in detail to see how everything connects.

Healthy body

Healthy bodies need strong immune systems. This works inside us keeping out diseases, fighting off illnesses and healing us when something causes infection or when we have been injured.

Strong immune system

A strong immune system comes from good nutrition and a healthy lifestyle. We need rest and exercise, work and play, as well as clean air, clean water and good food. These things are even more important to balance if your immune system is deficient, such as with Human Immunodeficiency Virus (HIV). The immune system needs to be as strong as it can be for you to be as healthy as possible.

Dietary diversity

Eating many different kinds of foods from each of the food groups every day (as we described in the Better Meal and will look at more in the food groups section) is the best, and only, way to get all the nutrients needed to keep our bodies and immune systems as strong and healthy as possible. In addition to diverse foods in our diet, we need to include clean water as part of our daily diet.

Healthy soil

If a variety of different kinds of organic matter are returned to the soil, it will feed the soil the diverse diet it needs to stay healthy, very similar to the diversity that a human needs for health. Good, fertile soil is alive with tiny life forms that 'digest' the organic matter, so the nutrients can be absorbed again by the plants and trees and eaten by the animals.

A Diverse environment

If there is a wide variety of trees, plants, and animal life they will provide the diverse organic matter that feeds the soil that feeds us. This is also much better for the management of water in the soil. Healthy soil absorbs and stores water better than degraded, exhausted soil.

Abundant clean water

A diverse healthy environment helps to filter and clean our water as it sinks through the earth's layers. If there is plenty of water stored underground there will be enough for all living things to thrive; humans, plants and animals.

So things continue to get better

The healthy food, water and environment that this cycle creates continues to get stronger over time, making people healthier, too. As the resources are managed better, and we work with Nature to improve our diet and the health of the environment, many things in life will get better.

Understanding your Diet

The word diet means 'way of life'. A person's diet is the pattern of meals and snacks they eat and drink. Let us look at your eating habits and why you eat the way you do, which started with the food your caregiver fed you.

As you grew up, other things influenced your diet: your community, culture, religion, friends, school, work, the time of year or the cost of food. People say they choose certain foods and drinks because they like them but tastes are learned and can be changed. Anybody, of any age, can learn to enjoy eating healthier food while still each having our own likes and dislikes – there are lots of foods from which to choose!

In Malawi a meal often is not considered complete without *nsima* and *ndiwo*. The *nsima* is usually made from maize, and the *ndiwo* is often a vegetable, but can also be a legume (beans) or animal food (meat, eggs, milk etc.). People will sometimes say they have not eaten if *nsima* was not part of the meal, even though they may have had a very good and filling meal! But *nsima* can be made with other things than maize and can be tastier and better for you.

There are also many foods and drinks in Malawi that people think of as 'just' snacks: cassava, sweet potatoes, green maize, fizzy drinks and sodas (called 'minerals' in Malawi), fruits, ground nuts, breads, *chikondamoyo*, *mandazi*, chips, etc. These are often good, nutritious foods! (But not the sodas!) Bodies do not know the difference

between a meal and a snack. Bodies only know what nutrients you have given it and how many nutrients there are. We need to consider which snacks and drinks are healthy and nutritious just as much as we think about this for our meals.

Small steps towards dietary diversity

Here are a few ideas that can help you move towards eating better, healthier meals:

- At one meal replace *nsima* with another staple
- Increase the amount of *ndiwo* on your plate and serve a little less of the staple
- Eat some fruit with your breakfast
- Replace sugary drinks with water, fresh 100% fruit juices or herbal drinks
- Use avocado or peanut butter type of spreads instead of margarine
- Change your bread from white to brown (whole-grain) bread



Think about why you eat the way you do, what is good about it and what needs to be improved. Then you can start to make a few small changes in the right direction.



Write down the changes that you can make in your diet.

Topic 3: Malawi's Six Food Groups

Food groups are a way to organise different kinds of food, according to what part they play in keeping a body healthy.

Different foods contain mixtures of nutrients but there are usually particular nutrients that decide which group that food belongs in.

Food groups are very important to Food and Water Security (Number 3 on the Pyramid of Nutrition Needs).

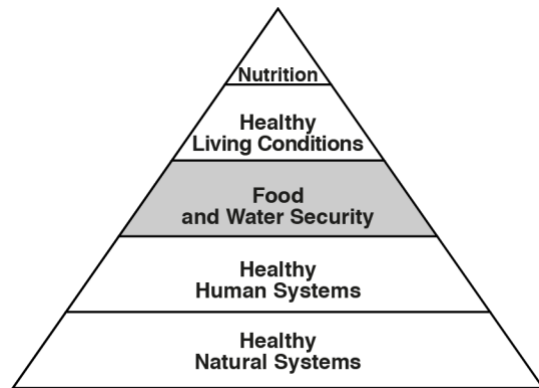

The Malawi Food Groups Circle

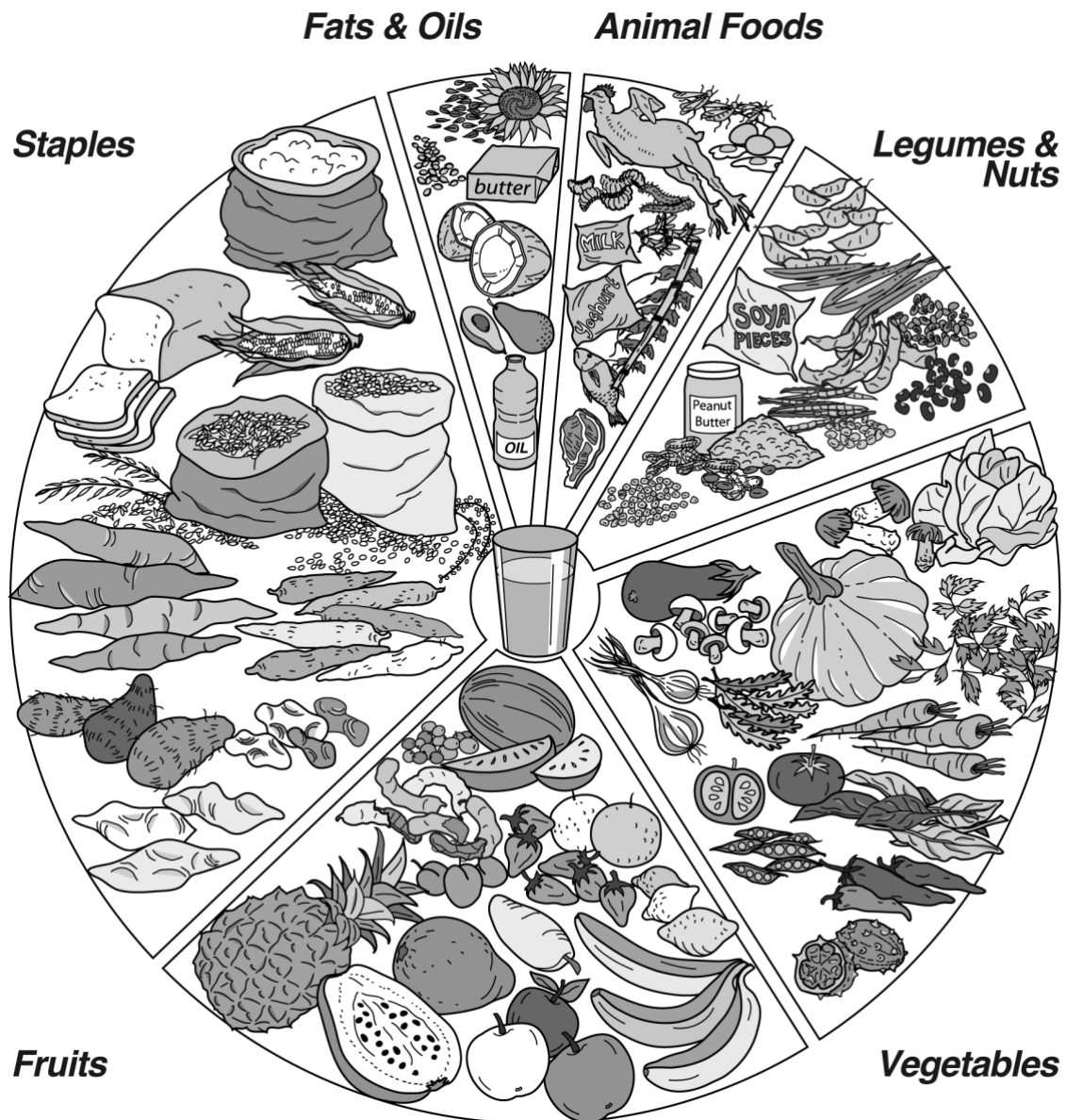

This image shows many different foods arranged into Food Groups. We will look at each of the groups, starting with what you should have the smallest amount of and increasing to the largest group.

Most of the time you can tell which group a food or drink fits into by how it grows, looks, tastes, feels in your mouth or what you know about it already. Most people know that oranges, apples and berries are fruits, for example, or that meat, milk, fish and eggs are animal foods. There are, however, a few exceptions:

- Tomatoes are actually fruit (because they bear seeds inside their flesh) but they are low in carbohydrate and high in vitamins so they are in the Vegetable Food Group.
- Avocados also grow like a fruit but you can tell by the way they feel in your mouth, smooth and creamy, that they have a lot of fat and oil in them so they are part of the Fats Food Group.
- Potatoes grow as a plant and often are found in 'vegetable' gardens, but they are very high in carbohydrate and are treated as part of the Staple Food Group.

Fats and Oils



The main nutrient is fat. They can also be a good source of vitamins and minerals. Fats can come from oilseed crops (pumpkin, sunflower, sesame), animal fats (butter, lard) and some fruit crops (avocado, coconut, olives).

Some fats are oily and can be pressed from a variety of seeds from other food groups (groundnuts, soy, vegetables like mustard (*mpiru*) or corn). This food group is needed in the smallest quantities.

Animal Foods

Main nutrients are proteins and fat. Also, a good source of vitamins and minerals. These foods are all of animal origin; meat, eggs, dairy, fish, insects, etc. Fats from animal are found in the Fats Food Group.) Vegetarians limit or do not eat foods from this group (vegans). They get all their nutrients from the other food groups instead. There are many health benefits to a vegetarian lifestyle, but, whatever you choose, remember to only eat a small portion of your overall diet from this group.



Legumes and Nuts



Main nutrients are proteins and carbohydrate. Legumes and Nuts are good source of vitamins, minerals and fibre. Soybeans and nuts also contain fats. Legumes are seeds that are enclosed in a pod, like beans and peas, and they can grow underground or above. Tree nuts are often found inside a fruit. There is often a starchy feel to legumes. The carbohydrates make it easy to make flours from this food group. High fat legumes can be made into pastes (peanut butter). Legumes are very good for soil fertility as they put nitrogen back for other plants. (More about this in Part 2, Topic 18, Soil Fertility.)

Vegetables

Main nutrients are vitamins, minerals, fibre and water. Vegetables have some protein very little carbohydrate (which helps to separate it from the fruits group). Vegetables come in a variety of colours and often have strong flavours (spicy, herby) with very little or no sweetness because of the low carbohydrate. Vegetables can be fruits, leaves, fungi, roots or bulbs – the group gives very diverse micro-nutrients when all the variety is taken advantage of. Herbs and spices for flavour or medicine (mint, mpungabwe, lemon grass) are often part of this group because of the nutrients they contribute to the diet.



Fruits



Nutrients are carbohydrates, vitamins, fibre and water. Fruits also have minerals and medicinal properties, especially in edible skins (apple, mango, citrus) and edible seeds (passion fruit, papaya and watermelon). Fruits have more energy than the vegetable group, because of the fruit sugars (carbohydrate) they contain. You can usually taste the sweetness of fruit, the tartness from the vitamins and visually see the variety of colours each providing different nutrients.

Staples

The main nutrients are carbohydrates (starch) and fibre. We can get many other nutrients from staples but it depends how we process them. Staple Foods include grains (millet), starchy roots (yams), and starchy fruits (green bananas).

Skins of edible staples, such as Irish or Sweet Potatoes, have a lot of fibre, vitamins and minerals. Whole-grain staples, like maize flour (mgaiwa), brown bread or brown rice have more fibre and other nutrients than processed staples like white maize flour (ufa woyera), white breads or white rice.



Water

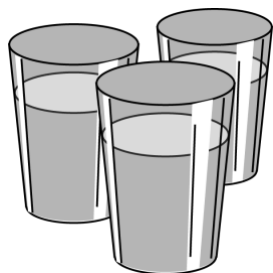

Water is not one of the Food Groups but it is one of the most important parts of a healthy diet. Adults in hot climates need to drink 3-4 litres per day. Water is drunk to hydrate ourselves because the body needs water to process other foods, and to make and clean the blood in your body. We also drink water for the minerals it contains, but processed water usually has very few nutrients.

Food and drinks with no nutritional value

Some foods do not fit into these food groups simply because they contain very few or no nutrients. They should be avoided or only used in small amounts:

- Processed white sugars
- Fizzy, sugary drinks and concentrates such as *sobo* and squash
- Sweets, candies, cakes, etc.
- Alcoholic drinks like beer, wine, strong spirits
- Caffeine drinks like coffee and black teas

In addition to having no nutritional value, processed sugars are unhealthy for your teeth. They give you instant energy but nothing else that is useful for your body and they are increasingly blamed for many health problems. The less you eat of these items the better for your health and your diet. (You will find a Summary of the Food Groups in Part 3, Appendix 2, Menu Planning).

Foods for Energy, Protection and Growth

In the past, Malawi had 3 food groups but this limited diversity and did not make it easy for people to understand about getting all the nutrients they need, so each group was split in two and now there are the 6 food groups that we just reviewed. Certain nutrients lead each of the three main jobs that your body needs:

Energy foods (to make you GO with energy!)

Energy comes from Carbohydrates (from Staple foods, legumes and nuts and fruits), Proteins (from animal foods and legumes), and Fats and Oils. We should get most of our energy from carbohydrates, some from protein and a little from fats. The micro-nutrients do not give energy, but they play an important part in turning the food you eat into energy that your body can use (especially the B vitamins).

Protection foods (to make you GLOW with health!)

Vegetables and Fruits provide vitamins and minerals (and some water). These are the most important nutrients for protection. All of the food groups can provide us with vitamins and minerals if we choose mostly dark and brightly coloured foods, and take care in how we process and prepare our diets. All the nutrients end up working together for protection. The system in your body that fights off diseases is called the Immune System. It is built with certain cells that are made from protein and it has to have Vitamins in order to work. The immune system needs energy to do its work of providing protection from illness, disease or infection.

Building foods (to make you GROW healthy & strong!)

Legumes, Nuts, and Animal Foods provide protein, which is the major nutrient that builds the human body. Minerals are also very important because they hold all the proteins together (as we saw in the Nutrient Village. Luckily our protein foods are often the same foods that give us minerals. Again, all the nutrients work together for building. Energy is needed for building your body. Fat is needed to keep parts of the body flexible. Vitamins are needed as part of the body's walls for protection, like the intestines for example.

Eating a Balanced Diet

The nutrients work together to get their jobs done, so we need to eat them all in the right balance. Balanced means we do not have too much of one kind of nutrient and not enough of another. (We will learn more about this in Topic 5, Planning Food Amounts.)

A healthy body needs all the nutrients, in the right balance, to provide the energy, building and protection that you need. The balance of the nutrients is vital because they are all important for everything the body needs to do. Basically, the Staples should be the largest amount on your plate and Fats should be the smallest. How much of your plate do the Vegetables and Fruits take up? Putting these together should take up as much space as your Staple.

Eating too much Energy for your lifestyle can make you put on weight.

If you keep putting on weight you can grow obese (very fat) and you may have problems with your heart, your breathing and your joints. Some cancers are caused by the wrong diet. People can be very over-weight but, because they are eating a poor diet without the right balance of nutrients, they are still under-nourished, usually from too few vitamins and minerals.

Eating too little Energy for your lifestyle can make you lose weight.

If you are too thin you might not have enough energy, as well as the other nutrients you need, for strength for working, playing, studying, thinking, etc. People who are too thin often have difficulty growing and fighting diseases, so they are more likely to have health problems.

It is also possible to eat the right amount of Energy and be the right weight for your body, but still not be eating well.

A person eating like this will not be too fat or too thin, but they will have other health problems because they are not getting enough other nutrients. Usually the vitamins and minerals are lacking, but it could be protein as well. Most people eat far too much processed staple foods and not enough of everything else. (We saw this when we looked at the Current and Better meals on page 6).

Topic 4: Food Security

Food security is making sure that we all have, and use, all the 6 food groups every day in our diets, in amounts that will make sure we are healthy, energetic and strong.

To reach the top of the pyramid, Good Nutrition, we need water and health in addition to food security. So sometimes you'll hear people use the term Food and Nutrition Security to remind us that there is more to consider than just beyond just food security to reach nutrition.

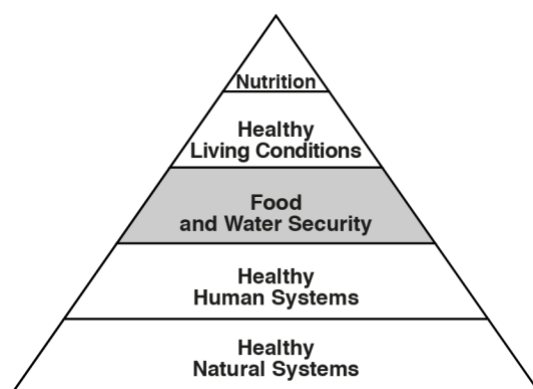

The internationally agreed definition for food security is:

“Food security exists when all people, at all times, have physical, social and economic access to sufficient, safe and nutritious food to meet their dietary needs and food preferences for an active and healthy life. The four pillars of food security are availability, access, utilization and stability.”

(Food & Agricultural Organization of the United Nations, Declaration of the World Summit on Food Security, Italy, 2009)

Foods Available Seasonally

Food Group	Food Name	Rainy / Hot Dec – Mar	Moist / Cool Apr – Jul	Dry / Hot Aug – Nov
Fats	sunflower seeds		✓	✓
	pumpkin seeds		✓	✓
	avocado pear	✓		
Animal Foods	chicken eggs	✓	✓	✓
	fish	✓		✓
	termites	✓		✓
Legumes & Nuts	cow pea		✓	
	<i>kamumpanda</i> (lima bean)		✓	✓
	<i>mtedza</i> (groundnut)	✓	✓	
Vegetables	bonongwe (amaranth)	✓	✓	
	<i>limanda</i> (hibiscus)	✓	✓	
	cassava leaves	✓	✓	✓
Fruit	papaya	✓	✓	✓
	<i>mbula</i> (hissing tree) fruit	✓	✓	✓
	mango	✓	✓	
Staples	green banana	✓	✓	✓
	yams	✓	✓	✓
	millet		✓	✓

In this example there is not much from the fats group available during the rainy season, but there are a lot of avocados. In the cool season the only animal foods available are chicken eggs. Vegetables are plentiful in the rains, up to the cool season, but then they are scarce in the dry season. The staples are strong most of the year with a variety of roots, tubers and fruit staples.



Think about what foods are available in each season in your area. When do you have most choice and lots to eat? When is it harder to feed yourself or your family?



List the foods you eat and what food group they belong to. Once you have a long list of when foods are available, you will be able to see the gaps. How can you start to fill these gaps?

Local Foods in Malawi

Maize came from the Portuguese, who got it from the Americas, as did cassava. Mangos came from India and cabbage from Asia. When people travelled, they brought their own foods with them, and when they returned home they took new foods back. Malawi has many of its own native foods that we should be proud of and that we should share! In fact there are over 600 foods listed in Appendix 1 of Part 3, Sustainable Designs.

So why are people complaining that they are hungry? What has happened to the wide variety of foods that Malawians used to eat? Think back to the Cycle of Dependency as we consider the following points. This list is just a beginning so discuss this issue further within your community and find solutions together.

Food equals maize

When most people think of food in Malawi, they think of maize. Maize still dominates diets, policies, programmes and food security budgets. However people are starting to change how they think about diversity and that is a very good thing! This discussion on maize dependency needs to continue while taking steps to reduce the dependency.

Food assistance and food insecurity

When people monitor 'food security' they mostly measure maize without counting all the food groups. This results in two situations that allow food insecurity. Both these cause problems.

Enough food, but not enough maize

There are often situations in Malawi where there is enough food from all the food groups, but there is just no maize. If there is enough food from all the food groups, this is food security. But, even so, a crisis is declared and the response is bringing in maize for food or maize seed and irrigation to make up for the so-called shortfall. This reinforces the idea for people that maize is the only real food and continues the cycle of dependence instead of breaking it.

Enough maize, but not enough food

The reverse is also true. There can be more than enough maize for everyone but not enough from the other food groups. This is food insecurity but it is not seen as a problem because there is enough maize. Maize can provide energy to fill bellies but it will not provide for building our bodies and maintaining our health. In the past people

often had enough diversity in all seasons to have different options for food. Even if some foods did poorly one year, there would be other choices - often referred to as 'famine foods'. Now this has changed and we do not have the diversity we had. But we have the power to change this! Food assistance is welcomed in time of crisis and has assisted a great number of people in the world but we can reduce the amount of assistance needed if we start to look at, and solve, the root causes of our problems.

Loss of knowledge

As people rely less on the variety of local foods around them, the knowledge about how to find and use these foods is also being lost. In the past people learned about their foods from their parents and grandparents and we need to revive this transfer of family knowledge. Also, our schools need to include this knowledge in the curricula, such as in Malawi's Productive School Environment programme, the agricultural curricula and social and environmental studies.

Loss of habitat

As land is cleared to grow maize, local plants and Nature's diversity is destroyed. As well as reducing the number and variety of plants and trees this also destroys the habitat of animals and insects. These were once part of an abundant food supply.

Burning and poaching

Malawians burn land every year to 'clean' an area, or clear more land for farming or to hunt for mice or small game. Burning does not 'clean' the land; instead it kills almost everything in the area. Repeated use of fire destroys soil fertility, plants, trees, the air, the habitat of animals (including bees) and many natural resources that could be used for food, medicine, building or thatching. Repeated burning interferes with the Nature Cycle (more about this in Part 2, Sustainable Designs) instead of working with it to become healthier and stronger.

In the past, all animals (including birds and fish) were heavily hunted which reduced them to very low numbers. Laws were put in place to protect wildlife but now poachers have taken over the exploitation. This situation can be reversed. We can develop a well-managed, fair hunting system to bring back the animal populations (including fish) so that the earth and people are cared for and we can share fairly.

Influence of a 'Western' diet

Foods of another culture are often seen as 'exotic' or 'better' than the native, indigenous foods. Natural, locally produced foods are seen as being only for people who cannot afford anything else. In Malawi people strive to afford foods like packaged products, sugary drinks, meats, oils, foreign fruits, vegetables, etc. These foods are often lower in nutrients than local foods and can be unhealthy if too much is consumed. They come at another cost too. Think about these things:

- All the time and energy used producing, processing, packing and transporting 'Western style' food and how this affects the environment with all the fossil fuels and packaging required.
- The impact of imported food on the economy. It requires foreign currency exchange and puts profits outside Malawi instead of in the hands of Malawians

Eating locally produced foods is so much better for your health, the environment and the economy. Luckily, many people, like you, are starting to ask the important question: how can we use local foods and food knowledge so that everybody can have all the nutrients they need while protecting and promoting a healthy environment?

Restoring Biodiversity

Increase awareness of local species

Learn about local foods by asking people in your community (especially the older people), by networking and reading about the subject. There are plenty of books and internet sites. In Malawi, we have the National Herbariums and Botanic Gardens in each major city. Most city councils have nurseries; several districts have research stations and all districts have agricultural offices. Each of these offices can guide you, as well as you contributing to their work.

Collect and plant local seeds

Collect seeds from nature and plant them everywhere. Start seed-sharing networks and let others know that you are interested in local seeds. In Malawi, there are several genetic seed banks at research stations that can assist you. Not everyone has the time, or is interested in, collecting, multiplying and saving seed. Learn what seeds people will buy and create a business that not only provides diverse seeds from all the food groups, but also teaches why it is important to increase diversity. Seed multiplication is a skill to be learnt but it is not too hard and the effort will pay off if you run a good business.

Eat local foods in meals and teach others about them

Once you have local foods established around your home, you can use them in your meals and experiment with lots of tasty recipes. Think of some creative ways that you can share foods i.e. at meetings, churches and schools. You could even market foods in your local shops and restaurants. You can teach others with demonstrations or just by having a friend over to eat with you! Make learning fun and interesting by coming up with activities like competitions to collect the most diverse range of seeds or coming up with a list of things to find in a scavenger hunt.

Create products with local resources

You could probably think of many ideas for good quality indigenous products to sell locally. Not everyone will grow their own food; some people will want to buy local food from you! Our markets sell more local products now and most imported products you see could be replaced with a local product.



Think about which of these issues are the same for you. What about in your community? Do you have other issues to address with the way you think about food resources?

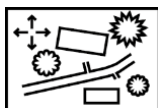

See the whole picture: Map your situation now, just a sketch. You will be making better versions of the map later. Use the blank page here or at the back of the book. (See Part 3, Topic 36, Mapping the Site for more information about drawing site maps.)

Sketched map as it is now

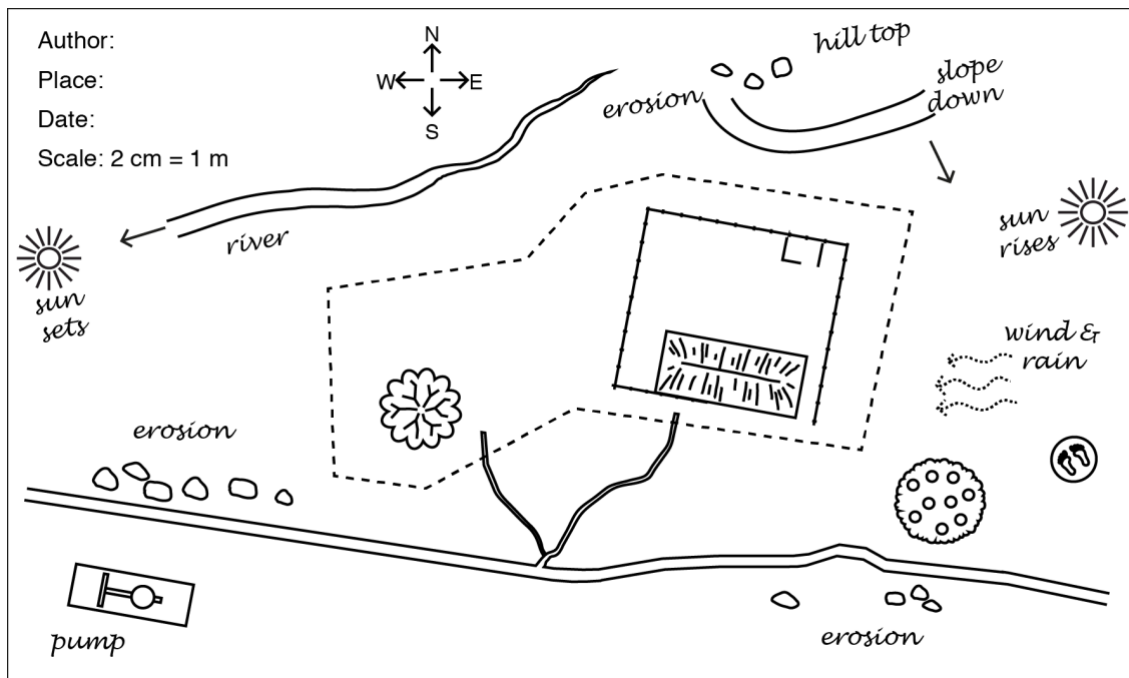

Designed map showing the plan

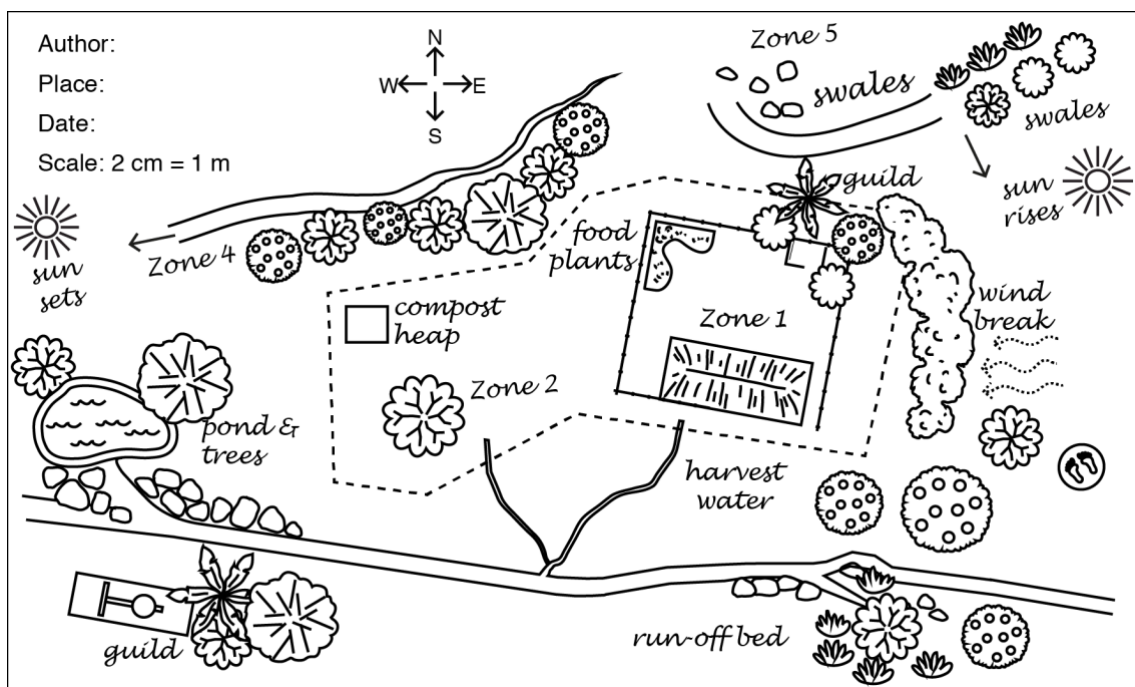

As you are reflecting, discussing and note taking, take some time to also focus on an area that you can apply your new ideas to. It could be your home, school, office, or preferably, a portion of one of these, something you can actually change. It can be, and should be, small to start with to build your skills, knowledge and confidence.

Aim for an area less than 20m x 20m – it doesn't have to be square, nothing in nature is. At the end of each topic you'll reconsider your map and notes and by the time we reach Part 3 of the manual you'll be ready to create your design.

Topic 5: Planning Food Amounts

Now that you understand the importance of nutrients and variety (diversity) in your diet, it is time to think about how much you need of each food group, and how to use different foods in your diet (or in your businesses).

There are several different ways to measure amounts of food, which are outlined here.

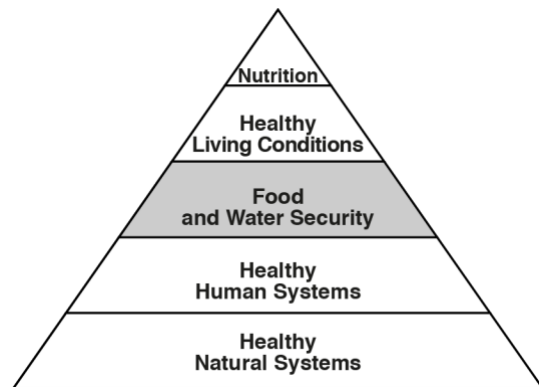

Estimating Food Measurements

Household measuring cups and kitchen scales are not common in Malawi, so here are some other ways to estimate food amounts. We will use some of these methods in the Creative Cooking recipes at the end of Part 1 of the manual.

Measuring food by weight, dry

Some products are sold by kg in the market, or packaged and labelled with its weight (grains, legumes, meats). Different foods have different weights so 1 kg of rice does not look the same as 1 kg of meat. Different forms of food will also look different. 1 kg of whole maize takes up more space than when the same 1 kg is ground into flour.

In this manual we will refer mostly to weights of uncooked foods.

- **Dry weight:** For seeds, staple grains, legumes, nuts and oilseeds
- **Fresh weight:** For staple tubers, animal foods, fruits, vegetables

Measuring food by weight, cooked

Weights of uncooked or dried foods change when cooked. Different types of foods change in different ways, but you will soon learn to estimate what happens to a certain raw or dried food when it is cooked. Here are a few common examples.

Dried grain or legume flours change most from raw and dry to wet and cooked. This is because they soak up water. They weigh about 4 times their dry weight when they are boiled.

- 1 cup (about 150g) dried and ground maize makes about 4 cups of *nsima*
- 1 kg of dried rice or legumes will swell into about 3 kg cooked
- 1 kg of pasta swells a little less. When it is cooked it will be about 2.4 kg
- Dried whole-grains and legumes swell and weigh about 3 times more when boiled

Fresh vegetables tend to get smaller when cooked. Tomatoes and green vegetables shrink down a lot when they are cooked. Firm vegetables, such as onions or pumpkin, change less, but they also shrink.

Meats shrink a little with most cooking processes but can swell a little when boiled. The weight of milk varies a lot with different cooking (processing) methods. Think about how different milk powder is compared to cheese or yoghurt.

Measuring foods by liquid volume

Use clean 500ml water bottles or 300ml beer / mineral bottles to measure liquid quantities of milk, oil, soup or stock, etc.

Measuring foods by the handful

Your hand size can be used as an estimate for a serving size for yourself. A large handful of food is about right sized portion for a large person. A small child's handful is about a child-size portion.

Measuring foods by energy content

Energy in food is usually measured in kilocalories (kcal). We often call them 'calories' for short. An adult needs about 2200 kcal per day, a school child needs about 1600 kcal and a pre-school child needs about 1200 kcal.

Use the measurements that best suit your lifestyle and what you have available. Get into the habit of looking at weights and measures on packaging and noticing what something weighs when you hold in your hands, what that feels like and how large it is. Look out for containers that you know contained a certain amount of food and use them in your kitchen.

Find out what the containers in your kitchen hold when they are full of liquid or food, whether it is your water container or your saucepan. You will get better at making estimates with your eyes, your hands and your own kitchen equipment as you practice.

Measuring Foods by the Spoonful



Chipande (plural is **zipande**): This is a wooden serving spoon in Malawi. They can range from $\frac{1}{4}$ cup up to 1 cup. The largest *chipande* can hold about 1 cup of food, which is about 75g of green leafy vegetables or a 100g serving of meat.

Tablespoon (Tbsp.): This holds 15ml of fluid or about 15g of powder (flours, salt, sugar). There are many different sizes of tablespoon in Malawi, but 15ml is the real tablespoon size. In recipes the word tablespoon is shortened to Tbsp.

Teaspoon (tsp.): This holds 5ml fluid or about 5g powder. It is one-third the size of a tablespoon so 3 teaspoons equals 1 tablespoon. In recipes the word teaspoon is shortened to tsp.

Guide to a Balanced Diet

Look again at the Food Group Circle and notice the lines separating each group. The size of each food group in the circle gives you a good idea how much of that food group should be in your diet. Think of all the food that you ate yesterday. If you put all this food on a plate, arranged into the different groups, like the picture, would it look like this? What have you eaten most of? What have you eaten least of?

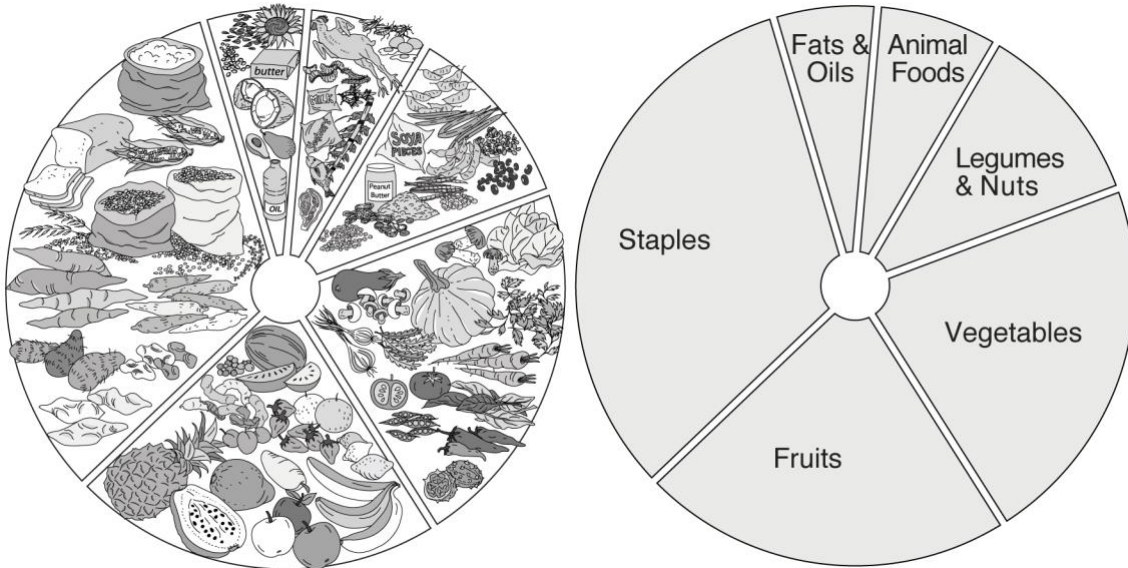

Amount of food from each food group for 1 day

The food groups can be balanced in many different ways, depending on what you have, like and what you need. The table below gives an example that balances the amounts from each food group to come up with the right amount of calories (kcal = the way we measure food energy) for average, normal weight people from different age groups. Notice how the amounts from each food group look about the same as the amounts of each food group on the Food Groups Circle picture above, but the circle is bigger for older / larger people and smaller for younger / smaller people.

Different size platefuls for different size people

Grown Adult

2,200 kcal, 1.4 kg = about 15 cups

- 50 g - Fats
- 100 g - Animal Foods
- 150 g - Legumes and Nuts
- 300 g - Vegetables
- 300 g - Fruits
- 500 g - Staples ($\frac{1}{2}$ grain, $\frac{1}{2}$ tubers)

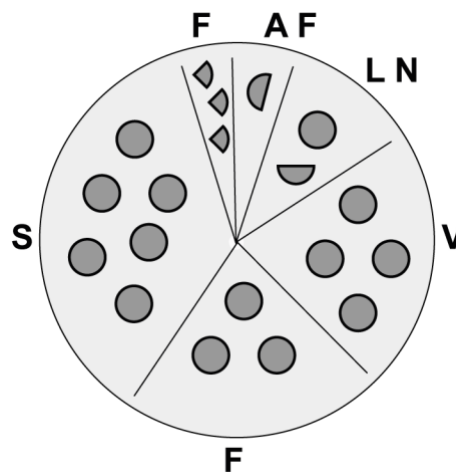

Primary-school Child

- 1,600 kcal, 1 kg = 11 cups
- 30 g - Fats
- 70 g - Animal Foods
- 100 g - Legumes and Nuts
- 200 g - Vegetables
- 200 g - Fruits
- 400 g - Staples ($\frac{1}{2}$ grain, $\frac{1}{2}$ tubers)

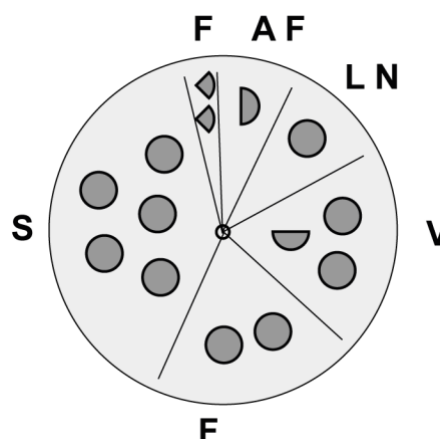

Pre-school Child

- 1,200 kcal, 0.75 kg = 8 cups
- 20 g - Fats
- 60 g - Animal Foods
- 75 g - Legumes and Nuts
- 150 g - Vegetables
- 150 g - Fruits
- 300 g - Staples ($\frac{1}{2}$ grain, $\frac{1}{2}$ tubers)

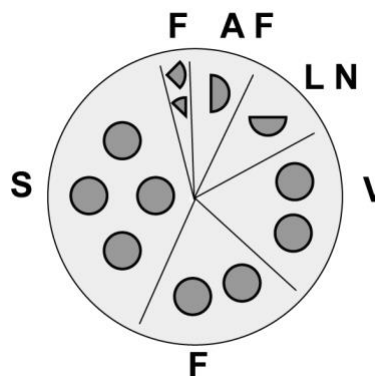

The food groups remain balanced for the different amounts that are needed. You can think of this as different sizes of plates or different sizes of spoons / *zipande* / handfuls. The table below shows an example of one full day's food for an adult.

Menu planning for 1 adult, for 1 day

- Each person's plate of food should look similar to the Food Groups circle by the end of the day. You do not have to eat every food group at every meal.
- You can mix the foods however you like through the day with a general aim of having 4 food groups at any meal or 2-3 at any snack.
- Meal planning can start with any food group.
- In the example given below we start with the staple, then add either a fruit or a vegetable (or both), then a legume or an animal food, and finally a fat if needed.
- Measurements are uncooked food. Grains and legumes will swell 3-4 times with cooking.

Group: Meal / Snack:	Staples	Fruits	Veg	Legumes	Animal	Fat	Meal / Snack Size:
Breakfast	150 g <i>chikondamoyo</i> with millet-nut-porridge	100 g <i>chidede</i> , honey, papaya		25 g nut flour in porridge	25 g milk in porridge		300 g
Snack	50 g bread	50 g baobab		50 g peanut butter		40 g avocado	190 g
Lunch	50 g nsima	100 g banana	150 g greens	75 g cowpeas		5 g oil	380 g
Snack	50 g popcorn	50 g masawo					100 g
Supper	200 g roast yam		150 g mushroom stew		75 g chicken	5 g oil	430 g
Total from each group:	500 g	300 g	300 g	150 g	100 g	50 g	1.4 kg
Approx. servings:	50g x 10	100g x 3	100g x 3	50g x 3	50g x 2	25g x 2	

We looked at the Current and Better Meals in Topic 2 about Food Choices. Let's compare these in more detail. Can you see the diversity the better meals and snacks bring?

Diversity is not about eating more food. It is about balancing the food groups and choosing the most nutritious foods within each food group most of the time. This means you have to consider your needs and your tastes. It also depends on what food supplies are available to you in your area, at different times of the year – and what you can make available. The pictures that follow show typical current meals and snacks and better meals and snacks.

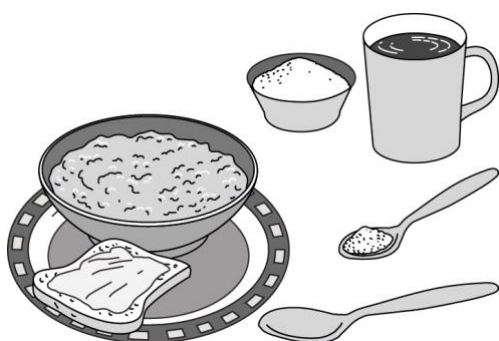

Current Breakfast

White bread with margarine, white cereal and, sugary tea; this breakfast will fill you up but won't keep you going.



Better Breakfast

Better to eat whole-grain cereal and whole-grain bread, fruit, water and herbal fruit tea with a little honey for a much healthier start to your day.

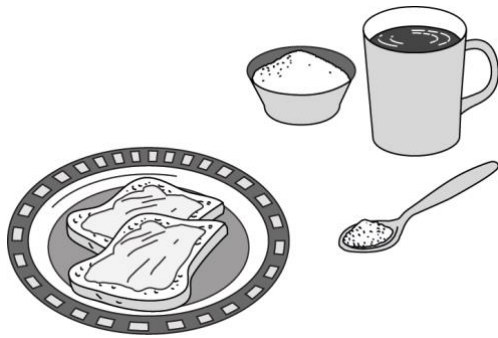

Current Snack

Bread made from white (refined) flour with butter or margarine and tea with sugar; this breakfast lacks protein, vitamins, minerals and fibre.

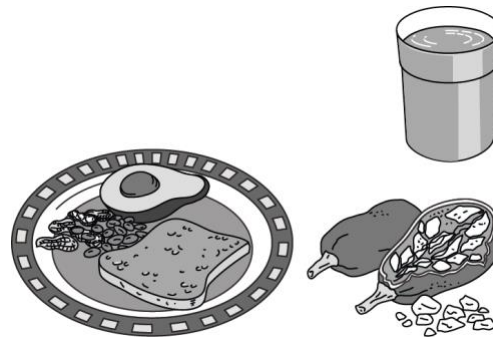

Better Snack

Better to eat brown bread with avocado, some peanuts and a baobab drink is more nutritious and tasty.



Current Lunch

With three scoops of refined *nsima* and a small amount of relish, this meal lacks water, proteins, fats, minerals, vitamins and fibre.



Better Lunch

A better lunch has a little less staple with a banana instead and more relish for fibre, vitamins, minerals and protein. A glass of water completes the meal nicely.

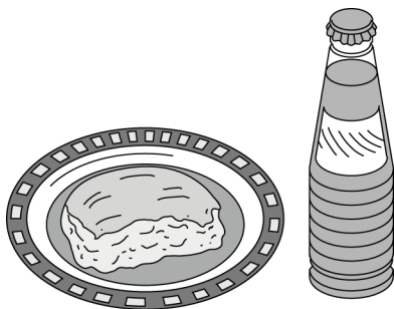

Current Snack

White flour in a bun and a fizzy drink will make you feel 'high' for a little bit, but won't keep your body going for long.

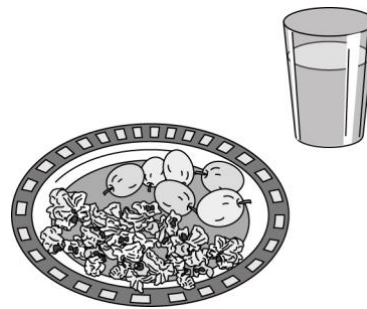

Better Snack

Popcorn, fruit and a glass of water will do a much better job of fuelling your body with energy, vitamins, minerals and fibre.



Current Supper

For a better supper choose different staples, not nsima and a small bit of ndiwo every day, every meal!



Better Supper

Try some yams, add salad greens, tomatoes or other vegetables with your meat or relish and some water for a tasty and nutritious meal with lots of diversity.

Each of the better meals and better snacks pictured here add up to a balance that is similar to the Food Groups Circle. Over the whole day the amounts from each food group are balanced with the others. These pictures are based on adult meals but portions for children would (of course) be smaller.

How Much Food Should You Save?

Now that we know how much a person should eat from each group, we can think about how much we need to save for the future. The table below shows the food for one adult, or five adults, for a day, or a month or a whole year.

Adult Food Needs by Food Groups		1 day		1 month		1 year	
		1 adult	5 adults	1 adult	5 adults	1 adult	5 adults
Fats		50 g	0.25 kg	1.5 kg	7.5 kg	18 kg	90 kg
Animal Foods		100 g	0.5 kg	3 kg	15 kg	36 kg	180 kg
Legumes & Nuts		150 g	0.75 kg	4.5 kg	22.5 kg	54 kg	270 kg
Vegetables		300 g	1.5 kg	9 kg	45 kg	108 kg	540 kg
Fruits		300 g	1.5 kg	9 kg	45 kg	108 kg	540 kg
Staples	½ grain	250 g	1.25 kg	7.5 kg	37.5 kg	90 kg	450 kg
	½ tuber	250 g	1.25 kg	7.5 kg	37.5 kg	90 kg	450 kg
TOTAL amount:		1.4 kg	7 kg	42 kg	210 kg	504 kg	2,520 kg

This would be an over-estimate for a family of five with children, as they need fewer calories than an adult. It is better to over-estimate food needs than under-estimate them. If we have estimated a bit more than we need then food losses will be less of a problem, but do your best not to waste / lose any food!

Extra food can be shared or preserved for later. In any family, village or country food can be spoiled, damaged or stolen, and we need to work at reducing food losses, as they are too high in Malawi (and too high throughout the rest of the world).

Food for one adult per year

People in Malawi are often advised to grow and save too much maize and not enough from the other food groups. The current recommendations of saving 300 kg of maize per year per adult is basing all calorie needs on maize, not leaving room for calories from other staple foods or any other food groups. Yet, as can be seen in the Malawi Food Group Circle, only about one third of our food should be from the staple group, and less than that from maize. The other food groups should make up two thirds of our diet. The Malawi Food Groups Circle, which comes from the Ministry of Agriculture, suggests that we save the following amounts:

- **180 kg of staple foods per adult, per year (not just maize!):**
 - Half of these (90 kg) should be grains like millet, sorghum and maize
 - Half of these (90 kg) should be starchy roots like cassava, yams, potatoes etc.
- **324 kg should come from the rest of the food groups, per adult, per year:**
 - 108 kg of vegetables
 - 108 kg of fruits
 - 108 kg of legumes, nuts, animal foods, fats and oils.

We can grow, buy and save more than this, just in case we have any food losses or unforeseen problems, or if we want to share or sell food.

Planning Food for Larger Numbers

You can use these estimates to plan food for larger groups at workshops, meetings, restaurants, schools and hospitals. By serving balanced meals and snacks and talking about environment, food security, diet, health, economy or any other suitable topic for your situation, knowledge can be shared and others taught to be more aware of the importance of good nutrition.

Reduce food waste to zero!

A lot of food is wasted in Malawi, especially after the harvest, when people feel they have plenty. But food waste happens all year, especially when large groups are eating. Think about all the money, time, energy and resources that went into the wasted food. Imagine the number of people that we could feed with what is wasted!

So, to avoid waste start with small helpings then add more if you are still hungry. If you are serving for many people keep foods in the kitchen and bring extra food out as it is needed. By doing this the foods (still in the pot or serving dish) will stay clean and can be shared with others, or saved for later. Prepare the right amount of food by planning properly. Protect leftovers so they can be used later. We will learn more about preservation and storage later in the manual.



What can you do to improve the balance of your meals? Do you have food waste? What happens to it? What issues do you have with food amounts?

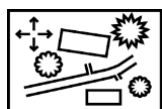

Where does the food waste from your family or your community go? Add this information to the map you have started drawing.

Topic 6: Healthy Body Weights

We have looked at how much weight of food we should eat (and save) and have learned a little about measuring food energy in calories, but how much should we weigh ourselves?

Everybody is different. How much you should weigh depends on your size, age, sex, level of activity and body type.

The Body Mass Index is a guide to help you have a healthy weight for the size of your body.



The Body Mass Index (BMI)

This calculation suggests how much mass (weight) you should have for your body size (height). If the score is too high you are probably over-weight, meaning that you are too fat for how tall you are. If the score is too low you might not weigh enough and you could be too thin. Being too thin, or too fat, can lead to serious health problems. These calculations are not used for pregnancy or during breastfeeding. Nor are they used for children and adolescents. There are special calculations and guides that take into account these times of life where rapid growth is taking place.

To find out an adult's Body Mass Index take their weight in kg and divide it by their height in metres squared. 'Squared' means you multiply the number by itself, for example: 3 squared (written like this 3^2) is 3 times 3 (3×3), which equals 9. So $3^2 = 9$).

The BMI calculation is written like this:

$$\text{Height} \times \text{height (in metres)} = \text{m}^2$$

$$\text{Weight (in kilograms)} \div \text{m}^2 = \text{BMI}$$

The normal adult BMI range goes from 18-25. If the BMI is less than 18 the person is likely to be underweight (too thin). If the BMI is over 25 they are likely over-weight (too fat). Here are two sums working out the BMI of two adults, both in the normal range:

The first person weighs 60 kg and is 1.80 metres tall; the BMI Calculation:

$$1.80 \text{ m} \times 1.80 \text{ m} = 3.24 \text{ m}^2$$

$$60 \text{ kg} \div 3.24 \text{ m}^2 = 18.15 \text{ BMI}$$

This person's body mass index is 18.15. This is in the normal range and the person is probably a good weight for their height. They could be a little heavier and still be in the normal range, but they should take care not to lose too much weight or they may become too thin.

The second person weighs 70 kg and is 1.70 metres tall; the BMI Calculation:

$$1.70 \text{ m} \times 1.70 \text{ m} = 2.89 \text{ m}^2$$

$$70 \text{ kg} \div 2.89 \text{ m}^2 = 24.22 \text{ BMI}$$

This person's body mass index is 24.22 and this is also in the normal range. The person is probably a good weight for their height. They could be a little thinner and still be fine, but if they gain too much weight they may become over-weight.

Maintaining a Healthy Weight

People use the energy they eat in different ways and at different rates (speed). Some people find it is easy to lose or gain weight and other people find it hard. This is because everyone's body is different. You'll need to learn and think about your own body and lifestyle to know how to make healthy changes. Whether you want to lose weight, gain weight or stay the same you need to consume all 46 nutrients that your body needs.

Balance the energy used with energy eaten

In addition to balancing nutrients, you will need to understand energy balance.

- We start gaining weight when we eat more energy than our body burns; and
- We start losing weight when we eat less energy than our body burns.

Energy Burned: By increasing your exercise you can burn more energy, such as by walking, running, farming, pounding grain, washing clothes, playing sports, lifting weights, carrying children or heavy goods, etc. Being still and sitting most of the day burns very little energy.

Energy Eaten: Food groups that give the most energy are staples, fats, animal foods, and some of the legumes and nuts – such as soy and nuts. Foods vary in energy within each of the food groups and the table below gives some hints on how to select lower or higher energy foods from the food groups. There are other high calorie foods outside of the food groups often labelled 'junk' foods that have a lot of sugar, alcohol, salt and fat. The nutrient levels in these 'junk' foods are usually very low and they should be minimized or avoided.

High and Low-calorie Foods (examples):

This table shows how many Kilocalories (Kcal) there are in 100 grams of selected foods:

Food Group	Kcal 100g	Lower Calorie	Kcal 100g	Higher Calorie
Fats	200	Avocado, olives	600 to 900	Almost all fats, oils, oil seeds, oil seed pastes, butter, fresh coconut
Animal Foods	100	Low fat milk and dairy products, most fish, rabbit, quail, tripe	200 to 500+	Milk, yoghurt, <i>chambiko</i> , cheese, ice cream, meats, fatty fish, dried powdered meats, fishes and milks
Legumes & Nuts	200	Most beans and peas	400 to 500+	Soya, groundnuts, nuts from trees (almonds, <i>muula</i> , macadamia, cashew), dried powdered beans
Vegetables	50	Almost all vegetables, raw or cooked	100+	Almost all dried powdered vegetables
Fruits	50	Most fruits, watermelon, pineapple, citrus, papaya, roselle, guava	100+	Bananas, dried fruits, honey
Staples	100	Starchy roots, raw or boiled	200 to 400+	Cereal grains, starchy root flour

Energy requirements

Most adults, of an average size and activity level, need about 2,100 calories a day, which is about 1.4 kg of food. Some people need more calories and others need less. The following points are a good general guideline:

People who need to eat *more* calories than average:

- Very active people doing hard physical work
- People whose body burns energy quickly
- Taller than average people
- Pregnant or breastfeeding women
- People who are underweight (too thin)

People who need to eat *fewer* calories than average:

- People who are not very active (sitting much of the day)
- People whose body burns energy slowly
- Shorter than average people
- People who are overweight (too fat)

Understanding calories and weight

For every pound of fat (2.2 kg) that a body is overweight, that person consumed about 3,500 calories more than their body needed. When you eat calories that your body does not need those calories are stored as fat for later use. This means you put on weight. Too much of this fat causes health problems.

Not all weight gain is fat; weight gain can also happen if you start exercising more because your body builds muscle, which weighs more than fat. If your body is holding water it can also causing you to gain weight.

Weight gain can happen quickly. For example, if you eat just 500 extra calories a day it adds up to an extra 3,500 calories a week. This could add 2.2 kg of fat to your body weight, depending on your activity level. Five hundred calories might be from low nutrient foods, often called ‘empty calories’ such as 3 bottles of fizzy drinks, or beer or a chocolate bar. Or, 500 calories could be from nutrient-dense foods (food that have many nutrients per calorie) such as 2 avocados, 120 g of nuts, or 150 g of uncooked grain. Either way, if you are gaining weight, the calories are more than you need for your body type and activity level!

Weight loss usually happens more slowly. The opposite is also true: to lose 2.2 kg a person needs to reduce 3,500 calories. This could be done in a week by reducing 500 calories a day. You can do this by eating less and / or doing more exercise – usually you need both. The healthiest way to lose weight is to make permanent improvements in your overall lifestyle. . If you are currently gaining weight, you will need to reduce your daily intake so that you stop gaining weight, and then on top of that, reduce by another 500 calories to burn off your excess weight. It isn't as easy to reduce by this much in a week, so you might need to give yourself a little more time to adjust.

An example: Think about an adult who has been gaining weight. They need 2,200 calories every day for what their body burns, but they have been eating 2,700 calories every day and not getting enough exercise. (So they were eating 500 calories more every day than they were burning).

They should reduce their intake to 2,200 (to stop putting on any more weight). Then, they should reduce the amount they eat by another 500 calories a day to lose the weight that was gained. This would mean that they should eat about 1,700 calories a day to lose the extra weight and they should stick to this new calorie amount until all the extra weight is lost. They should also try and increase their activity level (take more exercise).

When they have reached a good weight for their height they can eat a normal amount again (2,200 calories). They need to be careful not to go back to their old habits of eating more than they need and causing weight gain. They should also make sure that they exercise enough to stay at the healthy new weight.

Tips for Losing Weight

If you want to lose weight you need to increase the amount of energy burnt and reduce the amount of energy you eat and drink. Usually it is best to do both of these things.

Burn more than you eat

Increasing the energy that you burn aims towards helping your body use some of the energy that it stored as body fat. In addition to helping to maintain a healthy weight, exercise makes muscles, bones and organs (like your heart and lungs) stronger. Exercise also helps you to relax and can help you to feel less stressed. Try to exercise for at least 30 minutes 5 times a week, or for 20 minutes every day. This could be walking quickly, jogging, playing sports or doing hard physical work (manual labour).

Eat less energy

An average adult might reduce their diet to 1,500 or 1,600 calories a day to take off their extra weight. This is about 1 kg of food in a day if you stick with the food group balance presented earlier. But an easy way to balance these calories and still feel full and satisfied is to eat less from the high-energy food groups (staples, fats, animal foods and high calorie legumes and nuts) and to instead eat more from the low energy food groups (legumes, vegetables and fruits). You can actually eat more quantities of food (1.2 – 1.3 kg) while still reducing your calorie intake! Amazing! Here are some hints for doing this:

Eat fewer high-fat foods

A little fat provides a lot of energy, so reducing the amount of fats in your diet can help you to eat less energy. But remember that fat is not the only food that provides calories and that you need to balance your whole diet and lifestyle. Choose from the healthiest fats: fish, oilseeds, nuts and legumes, olive oil, avocado and / or coconut, which are generally healthier than animal fats (meats, butter, etc.). Artificial fats like margarine should also be avoided or reduced.

Eat more high fibre foods

Foods with fibre help to make you feel full and are also very good for you. Plants are the only place to find fibre so eat lots more fruits, vegetables and legumes. Choose whole-grain staples like whole wheat, brown rice and *mgaiwa* (whole-grain maize flour). The bran and germ are full of fibre and nutrients. Clean, edible skins such as on Irish or sweet potatoes, apples and cucumbers are also high in fibre and other nutrients.

Drink more water

You should always drink 2-4 litres of water per day, but increase this to 3-5 litres, as it will make you feel more full. Drinking a glass of water before meals can help to fill you up and help you avoid overeating. Avoid drinks with sugar, alcohol and caffeine such as teas and coffees, *sobo* (flavoured squashes), artificial juices, fizzy drinks, sport drinks and alcohol. Sugar and alcohol add energy without any nutrients. They are 'empty' calories, and caffeine changes how your body burns calories.

Tips for Gaining Weight

If you need to put on weight you must take in more energy in than your body is using. You will still want to eat lots of nutrients but you will be looking for foods that are also calorie-dense (high in calories) while still giving you enough nutrients from all the food groups. An average adult might increase their intake to 2,700 calories, or about 1.6 kg of food to gain weight. Some ways to do this include:

Eat more energy-rich foods

Fats are the most calorie-dense of the food groups and nutrients, so choosing more foods from this group can help weight gain. Include more oilseeds like sunflower, sesame and pumpkin, which can be pounded into pastes and powders to make them smaller and easier to add to other foods. Butter, oil or fatty fruits like avocado, coconut and olive can be added to many dishes and snacks to enrich them.

Animal foods are also often high in fat, especially visible fat, like chicken skin or beef. Milk, fish or meat powders add concentrated fat, protein and micro-nutrients into a dish. These higher fat animal foods can help to put on weight but too much can be unhealthy for your blood vessels. Your diet still needs to be balanced with the other food groups.

Nuts and soy are the only high-fat foods from the legumes and nuts food group. Most other legumes tend to be low in calories. All are high in protein, fibre and micro-nutrients. Legumes tend to be bulky with fibre and fill people up fast. Eating them mashed (*chipere*) or as nut pastes (such as peanut butter or soy butter) helps people eat larger quantities more easily. Adding fats to legumes during preparation adds flavour, nutrients and calories.

Add calories to staples

- Avocado on bread
- Sunflower powder in rice
- Peanut butter in millet (adds protein too)
- Make *nsima* or rice with milk instead of water (adds protein too)

Add calories to fruits

Fruits are low in calories but high in vitamins, fibres and medicinal properties that keep the body functioning well. Add calories to fruits by pounding them with yogurt or cream – add honey for more calories and lots of nutrients. Some fruits can be dried as ‘fruit leathers’ or as powders, which makes them more concentrated, and easier to eat larger amounts.

Add calories to vegetables

Vegetables are low in calories but high in vitamins, minerals and fibre and some are high in protein, too. You can concentrate vegetables by drying and powdering them and adding them to recipes. When preparing vegetables you can add calories by adding milk, cream, eggs, oilseeds or nut powders.

Choose high calorie drinks

You need 2-4 litres of water in a day, but you can choose higher calorie drinks. A lot of calories can be put into a cup to drink by using powders or soft mashed foods mixed with liquid. Lots of drinks provide micro-nutrients and medicinal benefits, like natural juices, herbal teas with honey, milk and vegetable broths. Drink after your meal so that your stomach is not full of liquid, which can make you feel full and reduce your calorie intake.

Eat little and often

It is easier to eat 6 – 8 small, high-calorie meals and snacks during the day, instead of 3 or 4 large, bulky, high-calorie meals and snacks.

Nutrient-rich Meals for Low Appetites

When somebody is ill they often do not feel like eating, but they need lots of nutrients to help them get better. There are many ways to prepare foods which make them easier to eat and digest and really appetising.

Many of the tips for gaining weight are the same when preparing meals for sick people. But when people feel sick, the smell of food can make them feel worse and some foods can be hard to digest (fats, dairy). The ideas below help with nausea, diarrhoea, being tired, difficulty swallowing, fever and pain, which are all common symptoms of illness.

If you are cooking for ill people think of 'BRAT', which stands for Bananas, Rice, Apple and Toast. These types of foods are usually good to give to someone who is ill, as they are easy to eat and digest.

Reducing fibre and bulk

- Soft, mashed foods are easier to swallow and digest. Mash or powder foods to break up the fibre and concentrate the food.
- Make powdered food by drying foods in small pieces or chunks then pound or grind it into powder as needed. Foods store well for longer as dried pieces than as powder.
- Make juices from vegetables and fruits. Add dairy, if possible, or other higher calorie and nutrient-rich foods.
- Avoid fruit skins and seeds and other tough parts of foods.
- Cook vegetables to soften the fibre or make a well-cooked vegetable soup with herbs. There are many soups which combine all the food groups in one bowl.
- Eat refined staples, like white bread, white rice or crackers.
- Adding milk to cooked, mashed beans or potatoes adds nutrients and calories. Remove the skin if digestion is really bad to make the food easier to eat.
- If milk is hard to digest use yogurt, *chambiko* or water to make the food smooth.
- Add more nutrients with medicinal benefits and flavour with finely chopped fresh herbs, garlic or onions – depending on what the patient likes and can eat.

Summary Charts for Gaining or Losing Weight

Look at the shapes of each part of the circles in these charts, and compare them. Can you see how the proportions change depending on whether a person wants to lose or gain weight?

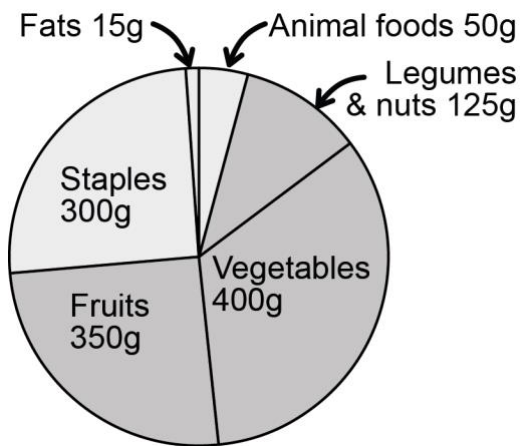

Approximate Adult Diet to Lose Weight

1.2 kg of food (1,500 kcal)

- Eat more from the right hand and lower half of the Food Groups Circle and less from the upper left.
- Eat more: Fruits, Vegetables, Legumes (from Legumes & Nuts)
- Eat fewer: Staples, Fats, Animal Foods, Nuts (from Legumes & Nuts)

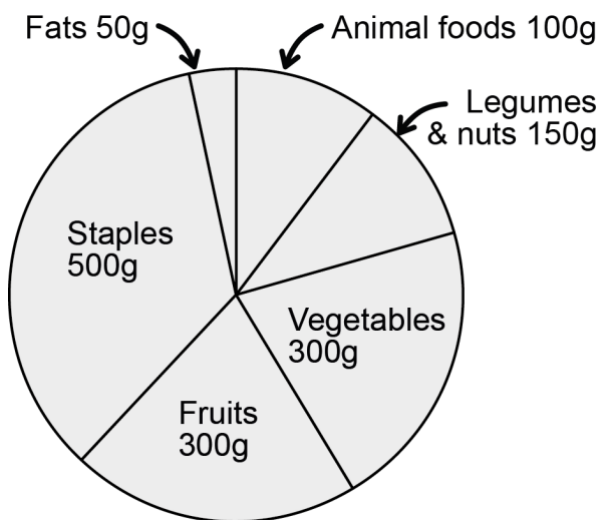

Approximate Adult Diet to maintain Weight

1.4 kg of food (2,200 kcal)

- Eat a diet that is in proportion to the Food Groups Circle, as shown left

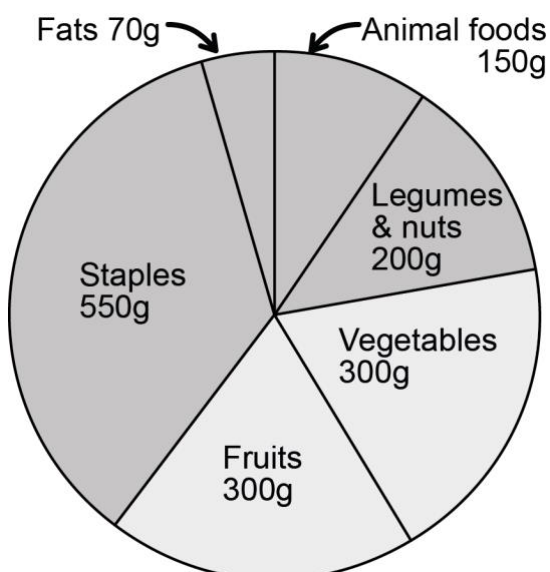

Approximate Adult Diet to Gain Weight

1.6 kg of food (2,600 kcal)

- Eat more from the upper left hand side of the Food Groups Circle and maintain the other groups as normal.
- Eat more: Staples, Fats, Animal Foods and Nuts (from Legumes & Nuts)
- Maintain: Fruits & Vegetables



Calculate your BMI. Are you a healthy weight for your height? Are you over-weight or under-weight? What about others in your family? Perhaps you know people who are ill and need to eat better than they do at present? Are there hints that you've learned that might help?



Write down your BMI and your weight. What do you need to do to have a healthier diet and body? Write down what members of your family need to do too. How can you help them to eat more healthily too?

Topic 7: Healthy Eating Habits

A lot of cooking education in Malawi is about making porridges for children and not much else. In many families there are only a few recipes and most people do not know enough about the 6 food groups to be creative with their cooking.

Now that you know more about eating well and eating a variety of foods, you can get really creative and healthy with your diet while improving the environment for everyone at the same time. Starting life with healthy habits is much easier than having to make changes later in life because of bad habits.

The more you live a healthy life the more it is good for you and those around you. Maybe you have not been as healthy as you could have been in the past but you can start your healthier life today. You can help the next generation learn about the health of their bodies and our environment much earlier than you learned about it.

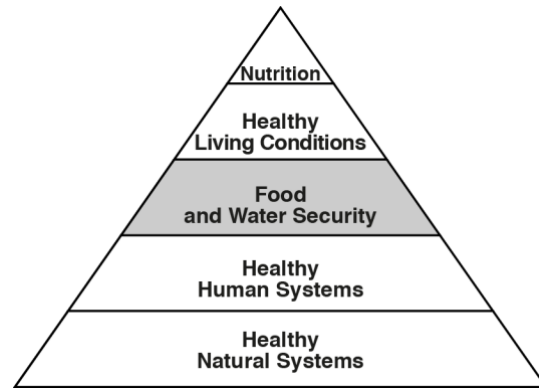

Learning young

Children learn from watching and copying. If their parents and other care-givers eat lots of fruits and vegetables, children will generally eat them too. If you are willing to try new foods, and show that you enjoy doing that, then your children will be more likely to try new foods as well. If you show that you enjoy an active life with lots of exercise, the children watching you are likely to enjoy this as well. Think about what eating and lifestyle habits you want your children to develop as they grow up?

Prepare foods together

Include children in the kitchen when you prepare meals and snacks. They will usually eat what they make and they will learn while they cook, especially if you chat about what you are doing and why. Be daring and try new foods together! This is a really good time to learn about food, health, the environment and culture, so make time to enjoy sharing it with children (or anyone!).

Celebrate food with others

Share and enjoy healthy meals with family, friends, neighbours and work-mates while exchanging stories, recipes, tips and advice for healthy living. Improve refreshments served at conferences, meetings, religious events and schools so that they are really healthy and refreshing breaks for you, as well as being good for our world.

Enjoy breakfast

It is the most important meal of the day to start you off with nutrients for energy, health and strength. If you do not have time to eat early in the morning before you leave home, start a breakfast programme at your school or work place. Everyone can bring something healthy with them to start the day with good nutrition and a chat.

Make healthy fast food

Make healthy snacks to keep in your office, or in your bag. Dried fruits, powdered fruit for making drinks, snack vegetables like cucumbers or *chocho / shushu*, carrots, nuts, pumpkin or sesame seeds, crackers, rusks and popcorn are all quick and easy snacks.

Be a good role model in your community

People often look up to religious leaders, politicians, government staff, musicians, business owners and other successful people. These people all have an influence, and can help Malawi become a healthier nation by setting a good example in living healthy sustainable lives. You too can be a good role model and lead your community towards healthier eating and a healthier environment.

Home remedies

There are many foods, especially herbs, which you can grow near your house that can be effective medicines for lots of health problems. Many good home remedies are written about in the books listed at the end of this manual. ANAMED (Action for Natural Medicine) is particularly good and full of useful information (Details in Part 3, Appendix 4 More Information). The elders in your community may also know about local remedies, so ask them and learn from them, combining their knowledge with what you learn from the health system, and with your own learning in order to make well-informed choices.

Questions and Fears about Food Changes

Changing your dietary habits is a change for your mind and body and it takes getting used to. Nutrient-dense foods can take more energy to digest because they are less processed, raw, or cooked for shorter times. The digestive system also has to adapt to the increase in nutrients and fibre. Two common things that people mention are changes to their bowels as their digestive system adapts, and changes in cooking times. Whole-grains and less-processed staples and legumes take longer to cook but vegetables not so long.

Digestion changes

It is important to make food changes slowly. You want everyone to enjoy the new, healthy diet, so start gently with them, and move at their own pace. Some hints for your transition:

- **Staples:** If you aren't ready for all whole-grain foods, start by reducing your refined grains with half refined grains (like white flour) and half whole-grains (brown flour) in your recipes. You can do this with rice, wheat flour, maize flour, chapatti, pancakes, etc. When you have got used to half white and half brown, you can increase the amount of whole-meal, and reduce the refined foods in the recipe even more. Just about any recipe can use whole-grain instead of refined foods. When you are used to it you will probably prefer the taste and the health benefits they bring.
- **Vegetables:** Cook your vegetables a little less each time so they have a bit more crunch and colour to them. Experiment with different raw vegetables, adding them more frequently to your diet as you get used to them. You will soon be eating a wider variety of vegetables and eating more salads every day instead of mushy, over-cooked vegetables!
- **Drink more water** as the amount of fibre in your diet increases. Water is very important for your digestive system to process your food efficiently so aim for 3-5 litres of water per day.

Different cooking times

Whole-grains (with bran and germ) take longer to cook, sometimes nearly double the time, so we need to see the whole picture of why we are choosing healthier foods such as:

- Whole-grains save days of processing time. Less time, money and energy is generally used for processing whole-grains. It takes days to process refined white maize flour but whole-grain maize flour takes just a few minutes.
- Reduced processing can put less pressure on the environment, with less fossil fuels or electricity used to power the mill to grind the flours more than once.
- Whole-grains are much more nutritious and healthier for your body. With more nutrients and fibre you'll have a better chance of living longer and stronger.
- There are ways to speed up cooking time and use less fuel, which we will talk about later in the book on page 61, Topic 12, Energy Use in the Kitchen

Before we start making tasty, healthy meals and snacks, let us look at protecting nutrients in food, food hygiene, and water for both cleanliness and food preparation.

We will also think about creating healthy, efficient spaces for cooking in. Hygiene, safe food practise and well-designed kitchens will assure our food is as healthy as it can be and prepared in the most efficient manner.



What good habits have you passed on to the young people that you know or care for? What bad habits have you passed on? Discuss how your behaviour affects the younger generation. Think about what habits you got from your parents. Good ones or bad ones?

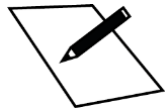

Write down a few things that you can do to develop healthier eating habits and to encourage the next generation to develop these good habits.

Topic 8: Protecting Nutrients

We have seen that a lot of resources go into growing and buying our food that many people do not think about.

These include renewable resources like soil, water, sun, air, time and human energy and non-renewable resources like fossil fuels for transport, chemicals and fertilizer.

Now we are ready to make the most of these resources that go into our food systems by being efficient with the foods we eat and retaining as many nutrients as we can, because this is the main purpose of food – to provide us with nutrients!



One way to assure you get the most nutrients is by just looking at the food. Plant foods that are darker and brighter are often higher in nutrients.

- The orange flesh of pumpkins is higher in nutrients than the pale green flesh of *mphonda* (a pale-coloured local gourd or squash).
- The dark green leaves of *limanda* (a local hibiscus) are higher in nutrients than the light green leaves of cabbage or lettuce.

Often nutrients are highest in the seeds, outer skins, bran, and germ of foods. When you eat the skins, make sure you wash the food well first!

- Edible skins: cooked potato skins, mangoes, plums, tomatoes, apples, etc.
- Edible seeds: pumpkin, melon, sesame, tomato, baobab, prickly cucumber, amaranth, etc.

Skins and seeds are not always edible! Make sure that you know what you are eating and do not eat the following:

- Non-edible skins: cassava, banana, papaya, etc.
- Non-edible seeds: plums, custard apple, *mucuna* (needs special processing), etc.

Foods that are processed less often have more nutrients. Processing often removes edible skins, bran and germ that could provide you with more nutrients.

- Dark brown carbohydrates (brown bread, brown sugar, brown rice) have more nutrients than white carbohydrates (white bread, white sugar, white rice, *nsima*).
- A baked potato is healthier than fried potato crisps. Crisps have more fat and salt, and the baked potato has more minerals, carbohydrate, proteins and fibre.

If throwing out any part of the food during preparation is necessary, be sure that it returns to Nature as seed or food for the soil. Later, we will talk about systems that can help you recycle kitchen waste, so nothing is lost.

Sun (or heat) water and air harm nutrients

The three things that harm our nutrients are easy to remember because they are exactly the same three things that every living thing must have to grow!

Once you have harvested, or prepared, your food you need to protect it from these things as much as possible. If you process foods using any of these things, drying fruit for example, you need to do so quickly and efficiently. The longer foods are left exposed to sun, water or air, the fewer nutrients there will be in what you eat.

As soon as a plant food reaches its peak ripeness then this is the best time to harvest and get all the nutrients that that food was intended to supply. Once harvested, you will want to eat it as soon as possible, as it will start losing nutrients through contact with air, sun and water.

Even if you do not harvest the food at its peak, once it reaches its peak it begins to degrade, eventually becoming soil again. Later in the manual we will talk about preserving foods for storage. Considering the sun, water and air will be important for preservation, too. For now we will look at maintaining and protecting the nutrients during food preparation.

Conserving Nutrients in Food

Eat raw plant foods for more nutrients

The best way to get the most nutrients from plants is to harvest the food and then eat it immediately. Many nuts, oilseeds, fruits, and vegetables are delicious this way. A benefit of eating food raw is that we save time and fuel by not cooking them! To eat raw plant foods:

- Make sure the food can be eaten raw! Some foods are poisonous if they are not processed properly.
- Wash the foods to clean off germs or chemicals that might be on them. If you have grown or bought organic food you do not have to worry about chemicals.
- Do not soak plants foods in water for long because nutrients are lost into the water. If you do need to soak food use the water in cooking if the water is clean enough, or use it to water your plants, if the water is dirty.

Cut pieces large

Cutting food exposes more of the food to air, water and sun. But, with some foods, if you do not cut them they will take a lot longer to cook or be harder to eat. So, before preparing the food, decide if and how your food should be cut up.

Keep foods as large as you can while considering the recipe you are making, cooking time and the age of the people eating. Children have smaller mouths and need smaller pieces than adults, but this cutting can also be done at the table, after the food is prepared.

Reduce cooking time

If you cook food instead of eating it raw, the food will be exposed to heat and, usually, water. Some tips for cooking:

- Use as little water as possible for the recipe. Use steaming or stir-frying, which uses very little water or oil.
- Get used to eating your vegetables so that they have a little bit of 'crunch' to them. They are much more nutritious like this!
- Prepare your plant foods close to the time that you are eating. Cook your carbohydrate and protein foods first, then cook the vegetables, or add them to the recipe, last.

Do not add baking soda!

Avoid using baking soda when cooking vegetables, legumes and fruits, as they will have reduced nutrient content. The baking soda makes the food soft but harms the vitamins, minerals and proteins.

Germinating and fermenting

Germinating and fermenting creates extra nutrients, which is great! These processes can also help your body to absorb nutrients. (We are NOT talking about alcohol fermentation to make beer or other alcoholic drinks!).

Germinating:

This is when they are allowed to start sprouting, to start growing.

- Most edible seeds can be germinated from their raw state to improve their nutritional value.
- People often use small legumes (like mung beans, *mphodza*), or oilseeds (sesame), or grains (millet). See the recipe for Sprouts on page 91.
- Do not use raw seeds unless you know they are edible raw.
- Some large beans (*kalongonda* or *mucuna*) are VERY poisonous! (Ask people who know if you are not sure.)

Fermenting:

This is the process of carefully aging foods that often improves the nutrient value of the food

Here are some good examples already used in Malawi:

- Germinated and Fermented Grains (*thobwa*): Germinated millet and / or maize pounded into flour for porridge, or slightly fermented to make *thobwa* (a non-alcoholic drink).
- Fermented Milk (*chambiko*): Clean milk is allowed to ferment in a clean container to make *chambiko* or sour milk, which is similar to yoghurt.



Think about what you can do to improve the nutrients in your foods. Are you doing things that harm your nutrients? What are you doing well?

Write down things you are doing well and what you can do to change any harmful practices.

Topic 9: Food Hygiene and Safety

As well as protecting the nutrients in food, our food and water must be safe before we eat or drink. Good hygiene is cleanliness.

This is even more important for people with weak immune systems, like young children, the elderly and people living with HIV.

Our food and the kitchen area must be clean and free of germs that can make us ill. Remember to 'WASH' for Water, Sanitation and Hygiene!



Germs

These are very, very small creatures (micro-organism). They are so small you cannot see them without a microscope. We will use the term germs to cover all types of harmful micro-organisms but other words you might hear are bacteria and viruses. (Not all micro-organisms are harmful and we have good micro-organisms inside our body, and in the soil, that are vital for our health and our environment.)

When germs get into food and water, they can cause illnesses and make a person sick. Your immune system fights off many illnesses without you knowing there were any germs in your body. This is why you need to eat a nutritious diet that will strengthen your immune system. (Remember the Cycle of Better Living earlier in the manual?).

Keeping yourself, especially your hands, and your food and water containers clean will help keep you healthy too. Problems with the human digestive system caused by germs can include diarrhoea, nausea, vomiting or fever. These symptoms are your body trying to get rid of the germ by either expelling it (diarrhoea, vomiting) or by killing certain germs with heat (fever). Some germs cause stronger symptoms (more serious illnesses) than other germs.

Germs get into our food and water in many ways

- From fresh manure (human or animal) being put near food and water. (This refers to fresh manure. Later in the manual we will talk about safe ways to compost manure (human or animal) into healthy fertilizer).
- Flies pick up germs from manure, and carry them onto our food.
- From our hands after we have been to the toilet, changed a baby's nappy, handled animals or picked up germs from many possible sources in our environment.
- From dirty containers, dishes, utensils or kitchen areas.

Germs like warm, moist conditions with something to eat

- Germs like Malawi's warm climate. It is not too cold nor too hot. The warmer seasons and places are best for germs.
- Moist conditions, like a damp towel or fresh food, are a favourite place for germs.
- Germs can thrive with the smallest amount of food – things that you cannot even see – but that might be hidden on a dirty cup or container.
- You can make life difficult for germs by keeping everything clean and dry, which removes germs and / or the food and water they like to eat.

Personal Hygiene

There are some simple ways to prevent the spread of germs, which can make you, and others in the family, sick.

Wash your hands frequently

You cannot see any of the germs but you can be sure that there are germs in many places. For example, wash your hands:

- Before handling or cooking food
- After going to the toilet or changing a baby's bottom or nappy
- After touching your mouth or nose (after coughing and sneezing for example)
- After touching animals
- After touching places other people touch such as handles, buttons, door knobs (at home, work, or car doors) hand-rails, phones, light switches, etc.

There are a lot of places where we transfer germs to one another. If we all wash our hands and surfaces frequently there is less chance of us spreading germs.

Wash your body and food preparation area often

In addition to washing hands, it is important to wash our body every day to remove germs and dirt. Pets and animals usually keep themselves clean, if given the right environment, but pets kept indoors sometimes need to be bathed. Household things and items that get daily use also need to be washed such as dishes, kitchen tools, kitchen surfaces, refrigerators, door handles, clothes, towels, bedding, etc.

Wash things thoroughly!

Scrub with soap and water. Rinse with clean water. If you do not have soap you can use wood ash or even sand to scrub away any stubborn germs.

Pour the washing water onto the earth near food plants

Washing water is usually great for the soil. Soaps are high in phosphorus, a nutrient that plants need, but take care not to put any bleach or other harmful cleaning chemicals in your water or near plants and animals. Besides useful phosphorus, wash water will have other nutrients in it too. There is also the rinsing water that comes after the soapy water and this is a perfect combination for growing just about anything you like. So, wherever and whenever you are washing, direct the water (known as grey water) into orchards or gardens. We will look at design ideas later in the book.

Air-dry things that have been washed

Avoid kitchen towels and cloths as germs love them because they are damp, dirty and warm. If you must use towels or cloths for cleaning, wash them often with soap and dry them well, preferably in the sun, which kills germs too. Even better than using a towel, let nature dry your washed items by using the air. (Conserve energy by letting Nature do the work for you!)

- Shake your hands after washing them and they will dry very quickly in the air.
- Dishes should have their own clean rack and clean area for drying. The heat of the sun helps kill any germs you missed in washing.
- Dishes should be stacked carefully so air can move around each of them and help them dry quickly. Do not let dishes sit in the moist conditions that germs love!

Make a tippy-tap

Here's a very simple, practical idea that will re-use a bottle and improve hygiene.

Make a few tippy-taps and put them in places that you need to wash your hands, like by the toilet, near the kitchen, near your animal pens etc. Keep the tippy-taps stocked with soap and filled with clean water. Every bottle is a bit different but you can work with what you have and experiment.

- Tie some string around the middle of a bottle, leaving a length of string above and below the bottle, and hang the bottle somewhere convenient.
- Poke a small hole into the upper side of the bottle, up near the cap. This is the air hole so the water will flow out.
- On the lower side, near the cap, poke a few small holes. This is where the water will stream out for washing your hands.

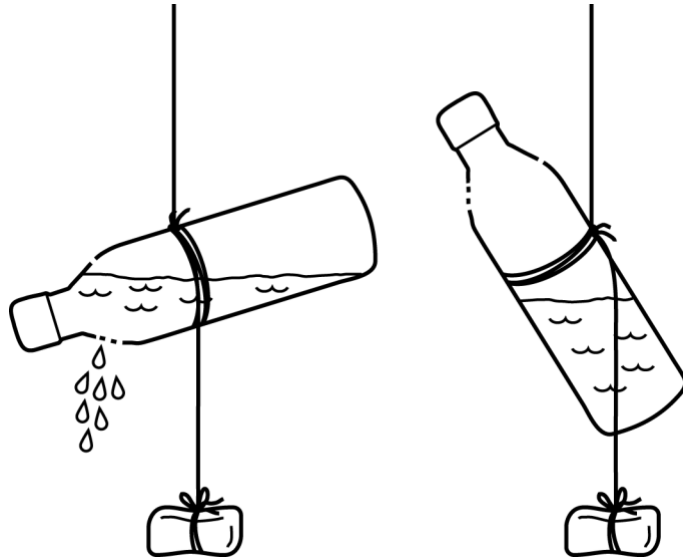

- Tie a piece of soap on the string below the bottle by carefully making a hole in the middle of the soap and threading the string through it.
- Fill the bottle with clean water and you are ready to use it. When you are not using it, tip the bottle so the cap end is up so that water does not drip out.

Use the tippy-tap

Use your wrist or elbow or your arm (not your dirty hand) to tip the cap end of the bottle down. The weight of the water will keep it tipped and water will sprinkle out onto your hands until you tip it back up the other way. Tip the bottle back up and use the soap. Scrub your hands. Tip the bottle back down to rinse, cleaning the soap too if it got mucky, then rinse your hands. Tip the bottle back up, ready for the next time. Fill the bottle with clean water as often as needed.

Soapy water is good for some plants so you could plant herbs, lemon grass, flowers and vines such as loofa sponges. (These plants like the phosphates in the soap.) The flowers and herbs also add a nice smell to the area.

Food Safety

As you can see, foods and water can pick up germs from many places. Foods can also have harmful chemicals or toxins on them that should not be eaten. For foods to be safe and nutritious, we have to think about all stages of the process, from production, when the food is made or grown, right up to consumption, when the food is eaten.

Growing and preparing your own food gives you the most control but we are not all able to do this and many of us rely on markets. It is important for food systems to have good standards, to be inspected and to be labelled with what has been done to the foods, so that we can make an informed choice about what we eat.

During production

A well-designed, healthy food production system is the start to the healthiest and safest food. Whatever species you are growing should have the right conditions for its needs.

If chemicals are used during food production they sometimes stay in the foods, even with the safest, most correct and proper use. It is possible to avoid using chemicals entirely by using the sustainable techniques in this manual. This will be covered more in Part 2, Topic 30 about Species Health, which looks at natural fertility, and prevention of pests and diseases through well-planned, sustainable designs.

Fresh manure (which is poo, faeces or excrement) has germs that cause illnesses. Only use manure (whether from animals or people) that has been composted / matured properly when adding fertility to your plants (see Topics 20 - 23 on Soil Fertility, in Part 2). For the production of animal foods, make sure that the animals have a healthy clean environment that is right for that kind of animal. Importantly, people (including you) need to wash their hands, keep things clean and develop good hygienic practices.

Another food safety issue is toxins (poisons) such as Aflatoxin, which is common in Malawi. Aflatoxin is produced by fungi in the natural environment. Poor production, harvesting and storage causes the problems. Good production, harvesting and storage practices can reduce or even eliminate the toxin.

During harvesting

Harvest plant foods at their peak for the best quality. Foods harvested at the right time are often easiest to store (for staples, oilseeds, legumes and nuts particularly), as well as best tasting and most nutritious.

Foods harvested too early or too late spoil faster. Grains, legumes and nuts that have not ripened properly will have more water in them, making it more difficult to dry and store them. Another problem is that their nutrients have not matured yet, for example, grains will have sugars instead of starch. This creates a dangerous environment where fungi can thrive and produce Aflatoxins, not only in our grains and legumes where we see it most often, but in other produce as well. Growing healthy strong foods and harvesting them at the right time is the first step in preventing your food from developing toxins or other germs that spoil the food and make it unsafe to eat.

Most foods taste better when they are properly ripe, especially fruits and vegetables. Try eating a ripe tomato, mango or avocado and comparing the taste to the same food eaten under- or over-ripe. The tastes are very different, and so is the nutrient content. A lot of people harvest vegetable and fruit produce too early so that it ripens during transport and storage, but this reduces the nutrients and flavour. This is another reason to build strong, diverse local food systems so that you have easy access to nutritious, tasty food.

During processing

After harvesting foods when they are mature, safe and full of nutrients, you want to keep them that way during processing so they can be then stored safely. There are lots of ways to process foods. We will look at some methods later (in Topic 16 Food Preservation and Storage, 72). Here are some important points for food safety. Germs and pests like warmth, water and food so, for food safety, you will be aiming for cool, dry and clean ways to process foods.

- Keep animals and insects away from the food processing area and make sure the area is suitable for the food with which you are working.

- Grains, legumes, nuts and oilseeds need to be well dried and usually need their husks or shells removed. This is often done outdoors on mats and then put in driers. There are different methods for different species. The most important food safety for this group is to separate out any rotten, bad seeds and then dry the good seeds well so fungi, moulds and pests do not thrive.
- Tubers, vegetables, fruits and fatty fruits (coconut, avocado) should be cleaned whole first (not always washed though, depending on the food). There are many methods that can be used to process them. Tubers tend to be stored fresh in a cool root-cellar or dried whole, grated or cut small. Grating and cutting make it easy for germs to get in, so only use clean utensils and clean people (hands especially).
- WASH (Water, Sanitation and Hygiene) is very important with vegetables and fruits. It is best to process these inside as they attract insects. The sweeter the food is the more it will attract insects when cutting it up (pumpkins, tomatoes, bananas, papayas etc.).
- Animal foods need care as germs can thrive in these products. There is plenty of food for them as well as moisture and warmth. Process animal foods as quickly as possible, in cool, clean areas that insects cannot get into (preferably inside).

During storage

Everything used for, and during storage needs to be clean so germs do not get into the food. Some types of food spoilage cannot be seen but can cause illness. You want to try to keep everything cool, dry and clean. Food containers should be secure, well-covered and appropriate to the food and processes you are using. The storage area (store room, warehouse, kitchen pantry, freezer, refrigerator, etc.) needs to be clean and well-designed. Check your foods often so you can see and recognise any changes, or problems with them. If you find any changes, do something quickly so the problem does not get worse and spread to other foods.

During cooking

Germs have many opportunities to get into food during cooking and preparation times. So remember WASH: Water, Sanitation and Health, and practise good, clean habits.

Start with safe, healthy foods: Know where your food comes from. Examine foods carefully. When you take food out of storage check the container for anything that might show damage. Remember, you cannot see all types of spoilage, so look for clues like broken, torn or stained packaging.

Clean preparation environment: The kitchen and dining areas should be clean with no animals or insects (Kitchen design is discussed soon on page 58) All surfaces, tools, dishes and pots must be clean.

Healthy food preparation habits

- The person preparing the food and the people eating must be clean: their body, especially their hands, and their clothes.
- Hand washing with soap and clean water should be done frequently.
- Kitchen towels are dangerous! Air-dry hands and dishes instead.
- Only use very clean towels for cleaning up.
- Take special care to keep animal foods cold or hot, not just warm.

- Tools and dishes that are used for animal foods, especially raw meat, need to be given special attention. Use different sets of tools (knives, plates, cutting boards, etc.) for meats than you use for plant foods. Foods that are eaten raw, like salads and fruits must be kept separately from raw meat or meat juices.
- Time the cooking and food preparation to match meal times. Foods lose nutrients and gain germs over time, so do not prepare too far in advance.
- Keep food hot (or cold, depending on the recipe) until it is served on the plates.

Making the most of left-overs

- Avoid leftovers by preparing only the amount of food you need. If there are leftovers put them away quickly and properly according to the type of food.
- Leftovers should be monitored and, if they are not suitable for humans, they can be given to animals (pigs, worms, etc.) or composted.
- Leftovers should be kept cool or cold in storage, either in a refrigerator or a freezer. Some foods can be dried, like cooked beans. Most leftover foods cannot be put back into long-term storage.
- Avoid repeated heating and cooling of the same food. It will lose nutrients and flavour, and is at risk of contamination (germs getting in).



What food hygiene and safety habits are healthy or un-healthy in your life? What about in your community, markets, schools and restaurants?

Write down what you can do to improve your food hygiene and safety. What problems and issues are there for your community? How could these be addressed?

Topic 10: Water Purification and Storage

Nature is a wonderful teacher for water purification and storage. We will learn more about water in nature in Topic 24 in part 2 of the manual. Basically what happens is this; the water falls from the sky as rain and soaks into the ground.

The water is naturally filtered (cleaned) as it sinks very slowly through many layers of rock, sand and earth below the ground surface. As it soaks through the earth it fills up springs and wells underground.

Unfortunately, in many places in the world, human practices have polluted water, for example by run-off and erosion. This often carries manure and poisonous chemicals into the water. We will look at some solutions for improving water management and protecting your water sources later in the manual (Part 2, Topic 22 Water Management) but, for now, it is safest to purify your water to make sure there are no germs in it.

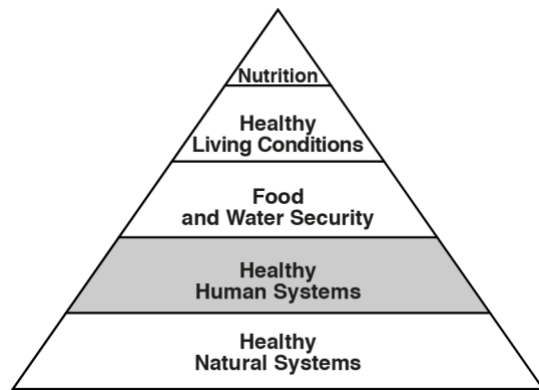

Methods for Safer Drinking Water

Water can be polluted with many things: dirt, chemicals, urine, germs and / or bacteria, but if you use a mixed approach to clean your water, you can greatly reduce the risk of drinking unsafe water. Here are the four steps you can use for safer drinking water: Sedimentation, Filtering, Disinfecting and Storing.

Sedimentation of Your Water

This means letting your water stand still for a while allowing the dirt in the water to settle, sink down and slowly fall to the bottom of the container. This is the 'sediment'. This step is useful if you can see that the water is dirty and brown or grey (turbid), but even in some seemingly 'clean' looking water, sediment can exist and only be seen after the water stands for a while. But, letting the water settle *only* removes dirt from the water, not germs, which are so small they float anywhere and they are too small to see. However, this step does help the water become cleaner and clearer.

To sediment your water:

- Fill a container with water and let it sit. The dirt settles to the bottom of your container.
- Carefully pour off the clear water into a clean container. If you do not want to wait for your bucket of water to settle, or if you have settled the water and want to make sure that the dirt does not enter the next container, put a cloth over the container that you are going to pour your water into, so the cloth will catch the dirt.

Filter your Water

The methods described below will trap most germs and dirt, but not 100% of them. Some water can be consumed after just using filtration, but you will not be able to tell by looking at it. If you do not have a testing kit it is a good idea to use Step 3: Disinfecting (boiling or solar) to kill any remaining germs if you plan to drink or cook with your water.

Plant ‘filters’ – sedimentation and filtering in one step

Certain plants, or their seeds, are able to ‘grab’ dirt and small germs from water and take them the bottom of the container where they can be separated from the clean water. One species that works well is the crushed seeds of the moringa (*chamwamba*) tree. The following method can treat 20 litres of water (20 litres is two large buckets full):

- Remove the hulls from the mature moringa seeds and pound them into powder.
- Put two tablespoons of seed powder into a small bottle with some water. Shake the bottle well for 5 minutes.
- Filter the mixture of water and seed powder through a cloth into the water that you want to purify. Then stir the water rapidly for two minutes.
- Continue stirring the water slowly for another 10 to 15 minutes to make sure the moringa is well mixed with the water.
- Let the water sit, covered, for an hour or two until the water becomes clear. You will see the dirt that has sunk to the bottom and it will be full of germs that the seed powder has caught.
- Carefully pour the clear water through a cloth into a clean container. It is about 90-99% germ-free at this point.
- To be 100% sure any remaining germs are dead use solar disinfection (SODIS) or boiling the water. Most moringa sites advise NOT to use chlorine in the water.

Filters that mimic layers underground

Most water filters copy the way the earth filters water through layers of rock. There are two filters that you can use at home; one is made with layers of sand, gravel, charcoal and cloth. The other uses a special method of making a porous clay pot so you will need to find someone who makes clay pots nearby.

Both methods require the filters to be cleaned and / or changed from time to time. As they trap the germs and dirt the filters will get clogged – this is why it is helpful to sediment the water first in step one, before pouring through a filter.

Charcoal and sand filter

You will need two large containers. One will sit on top of the other. The lower container is the one that the clean water is collected in.

1. Make many small holes in the bottom of the filter container (the top one), then:
2. Lay a piece of clean cloth in the bottom of the filter container, over the holes you've made
 - Add a 3cm layer of clean gravel
 - Add a 3cm layer of clean sand
 - Add a 3cm layer of crushed charcoal
 - Continue alternating several more 3cm layers of sand and charcoal until you are near the top of the container (as show in the picture)
 - Finish with a layer of clean gravel and another clean cloth
 - Put this filter container on top of the water-collection container. The bottom container could have a tap for easy access to the clean water. You could have two collection containers and move the filter from one to the other to assure there is enough clean water available. Be sure to always cover the containers.

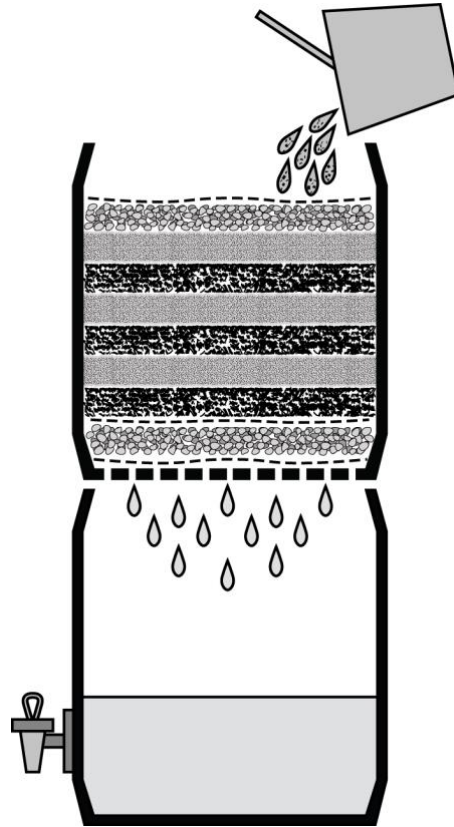

To use the filter:

1. **Fill the filter with water.** Slowly pour clear water into the top bucket that has the layers of cloth-gravel-sand-charcoal-cloth. Only use clear water so that the filter does not become clogged up with dirt too quickly.
2. **Wait while the water filters through...** Wait some time for the water to filter through the layers. It takes about 2-3 minutes for 1 litre of water to filter through the system. You will know when it is time to clean the filter (replace the sand and charcoal layers) when the water takes a long time to filter through. This is because the little tiny gaps and spaces are getting filled up with the dirt and germs that are taken out of the water.
3. **Disinfect the water:** If you want to be certain that germs are killed then see page 56. You might want do this for sick people or babies.
4. **Drink / use:** After the water is filtered and disinfected it is ready for drinking. If you use a cup to access the water, make sure it is kept clean and only used for dipping into the clean water, by people with clean hands. Put a well-fitting cover on the filter and water container to keep out dust, insects and germs.
5. **Maintenance:** You will need to clean or change the cloth and the gravel, sand and charcoal layers every few months. This depends on how often you use the filter and how dirty the water is that you are filtering.

Ceramic water filter

This is a clay filter that sits on top of a clean water container. It works in the same way as the charcoal and sand filter. To make this the wet clay is mixed with crushed husks or sawdust.

When the filter is fired in the kiln, the husks or sawdust burn away completely, leaving thousands of tiny holes in the clay. These holes catch the dirt and impurities. Sometimes minerals or charcoal are added to the clay, to help grab and kill germs better and to give the water a fresh taste.

Water passes through these tiny holes but the germs cannot get through, so they are trapped in the clay filter.

The filter needs to be cleaned with a clean wet cloth from time to time. The timing for the cleanings depends on how often it is used. When the water filters too slowly, clean the filter. After a number of cleanings the filter will need to be changed.

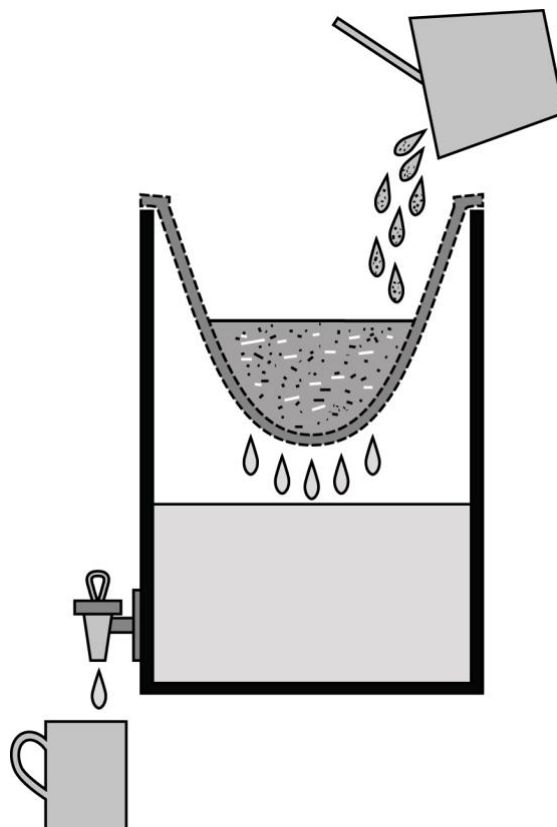

There are a few people in Malawi that make these ceramic pot filters already. If there is no one making them nearby perhaps you can learn to do it yourself or to help someone else start a ceramic water filter business? Talk with your district water officer. If they are not sure ask them to talk to their regional or national officer, or you can do this yourself.

Disinfect your Water

Germs cannot live in very hot temperatures so you can heat water to disinfect it and kill the germs. You can use this method on its own, but the water generally is cleaner and tastes better when you use sedimentation and / or filtration first. There are three ways you can heat water hot enough to kill germs:

- **Boiling water for 5 minutes** kills all the germs. Boiling means it is so hot it is bubbling. This uses more resources (firewood) than the other methods below, but you can reduce the amount of firewood used by using fuel-efficient stoves, paper briquettes, bio-gas or other form of sustainable stove. (To learn about fuel efficiency see Energy Use in the Kitchen, on page 61)
- **SODIS (Solar Disinfection):** Fill clear, clean bottles with clear water. Do not use muddy water. Put the bottles in a place that gets direct sunlight for 6 hours - If it is cloudy, you will need to keep the bottles in the sunniest place for 2 days. This method purifies the water and stores it at the same time, because you can use water straight from the bottle after it has been disinfected.
- **A Solar Cooker disinfects water** by concentrating the strength and heat of the sun. The water needs to be heated to 65-75°C for 1-4 hours, depending on the strength of the sun. If you are unsure, leave it for at least 4 hours in the solar cooker, in a sunny area. (To make a solar cooker see page 69.)

Store Water Safely

There is no sense in spending time and energy filtering the water and then letting germs get into the water afterwards. So keep the water container covered and only use clean hands, containers and cups! This will prevent contamination because the most common ways for clean water to get dirty again are:

- Dirty water containers;
- Uncovered or badly covered containers that let insects, dust and germs into the water;
- People with dirty hands using dirty containers with the water.

Clay pots are traditionally used for water storage but they need a lid. Clay pots are better for the environment than plastic containers (more about this later in the manual). Use a clean plate as a cover, another clay pot, a clean cloth, or ask a local potter to make covers for water pots. Make sure that your container is clean! Remember you cannot see germs so use soap and water to clean it thoroughly, then rinse it well with clean water so that your water doesn't taste soapy.

- Only use clean hands and cups to take water out of the container.
- If you are using a cup to scoop out water, the cup should be kept very clean and only be used to scoop clean water. The cup should have a handle that does not go in the water. Hands can put germs on the handle, and if the handle goes in the water so do the germs.
- If you can add a tap to a clay pot or bucket it will give you easy and very hygienic access to the water.



Do you have good water sources? Where does your water come from and how is it treated? Think about what you can do to reduce the risk of germs in your life and community.

Topic 11: Kitchen and Dining Spaces

To have healthy food, cooks and people you need to design healthy kitchen and dining areas. This is often not the case in Malawi. Kitchens frequently have poor air quality because of badly designed stoves and are difficult areas to work because of inadequate lighting.

There is usually not very much space for food preparation and no place for eating. Practices that put foods at risk for spoilage by germs, insects and animals are common.

Even with traditional earth and thatch buildings you can design your kitchen and dining areas to avoid problems, if you are creative. Even the smallest space can be designed for healthy food storage, cooking and eating. These drawings show examples to get you thinking but we will be looking at efficient energy use, storage, and building design later in the manual.

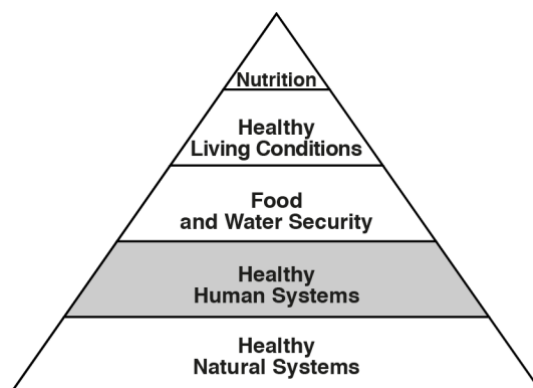

This picture shows a kitchen storeroom cut in half so that you can see the inside and the outside as well. All food and water is stored hygienically. Herbs and other frequently used plants are nearby to easily add to food and to allow for a place to recycle water.

Ventilation and light

If you are designing a kitchen think about where the wind and rain come from. If your roof overhangs properly and your windows are on opposite sides of the kitchen the air can flow through the kitchen, softly, without rain coming in. Think about where the sun rises and sets at different seasons and place your windows so that you get adequate light but avoid excess heat.

Storage

Use clean clay pots with covers, clean recycled jars and bottles. Hang foods and kitchen tools from the ceiling. Cloth bags or woven baskets can hold fruit and vegetables up high and keep the light off them and reduce attracting animals and insects.

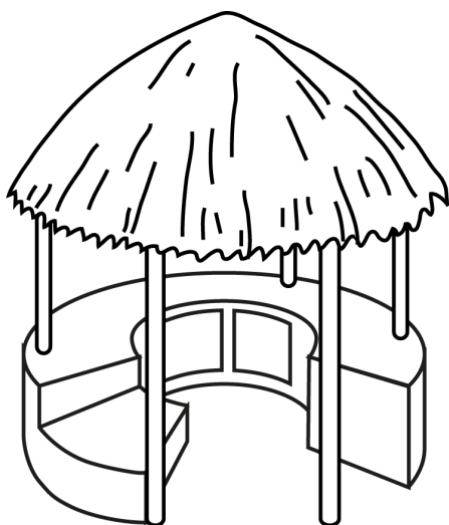

Space for working

A little bit of clean, flat space off the ground makes it much easier to keep food clean while preparing it. Food preparation work can take place on clean plates, platters or cutting boards.

Space for eating

Where do you eat in your family? People often eat at a table in their home. Sometimes men sit at the table but women and children sit on the ground to eat. Is this good for food safety? Is it fair to everybody? Keeping food away from dirt is much easier when something is used to keep the food off the ground. A clean plank of wood set on some stone, bricks, or mounds of earth is better than

putting food on the ground. Use mats to keep dust down and food clean. Wherever you eat make sure the area is clean before, during and after eating. This will help to keep yourself, and those you share your meals with, strong and healthy.

Space for cleaning

Every kitchen and dining area needs a place for hand washing, cleaning up spills and cleaning everything used for preparation and eating. A broom / mop, soap / ash, water and air-drying in the sun are your best cleaning tools.

- Brooms / mops – keep these clean and try not to raise dust when sweeping. Mops work well on hard surfaces, but need to be cleaned regularly and changed from time to time. Traditional kitchens need to be maintained with clay from time to time, although there are improved methods of making clay floors that can be learned from sustainable builders.
- Water can be collected from the roof in the rainy season into tanks, pots or into orchards.
- Hand-washing stations – these should be placed near the kitchen and dining areas. Water from the hand-washing station, or from washing dishes, should be used to water plants nearby (preferably food or medicines) so water is not wasted.
- Design an area for washing and drying dishes, with good ventilation and sunshine so that dishes dry fully and quickly in the air.
- Design clean areas for storing dishes and kitchen utensils as soon as they are dry.

Part 1, Topic 11: **Kitchen and Dining Spaces**



Think about your kitchen. What is good and what problems are there? Write down what you can do to improve your kitchen. What would make it a better place to prepare food? What about where you eat and clean up?



Note on your map where the kitchen is. Put in an arrow where the winds and rains come from. Add where the sun rises and sets. These directions may be different in different seasons, if you know them, add this as well, i.e. summer sun, winter wind.

Topic 12: Energy Use in the Kitchen

Food preparation in Malawi currently takes much more human energy and fuel energy than it needs to and this is robbing the landscape of our trees. We will learn more about why this is a huge and serious problem in Part 2 of the manual, which is about healthy and sustainable environments. For now let us just look a bit at what happens in the kitchen at home.

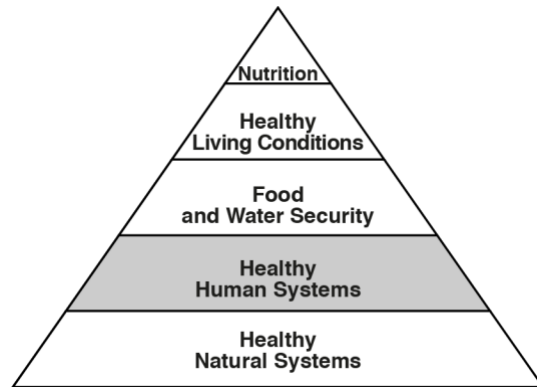

- Cooking on three-stone fires, or any smoky stove, is not efficient. You burn lots of wood for very little cooking and heat
- The wind blows on the fire and makes the wood burn much too quickly
- The wind blows most of the heat away from what is cooking and into the air
- Smoke from three-stone fires and badly designed stoves and kitchens causes breathing and eye problems
- Bad wood-burning practices, like using wet wood, too much wood at once or burning very large pieces of wood, also causes too much unhealthy smoke
- The wood for all these fires is cut from the lands around, leaving soil bare
- Bare soil gets washed away when it rains, or blows away when it is windy, because there are no trees and plants to hold it in place
- Not enough trees are planted to replace the number of trees being cut down for firewood, charcoal, building, etc.
- So we have less soil and trees, but more dust, smoke and health problems



(Adapted from: *Improved Cook Stoves Manual – Peace Corps Bolivia 2008*)

Three Stone Fires

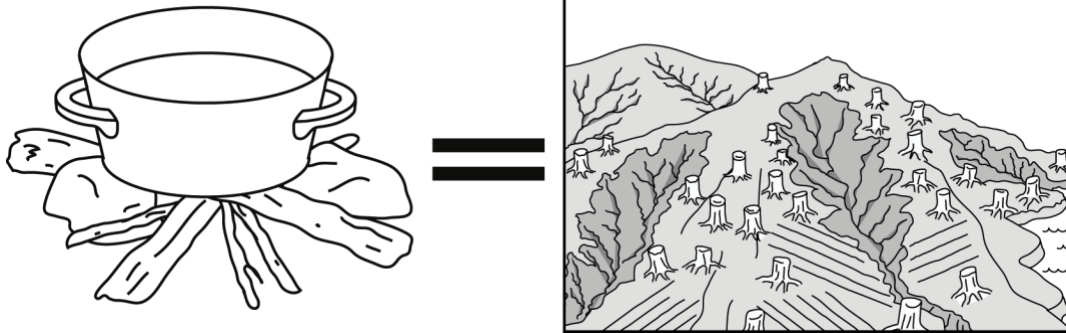

Rocks on hillsides appear to be growing, but really the soil is disappearing from around them. We simply cannot keep going like this. It is unsustainable for us and for other species that rely on the environment. What will happen when all the trees and the soil have gone? How will people in Malawi live if this happens?

We must use our resources more wisely before it is too late! There are many ways to do this: If we use energy-efficient cooking methods, and if we plant more trees than we use, the benefits will be both personal and environmental. People benefit in many ways when they adjust their cooking methods, so let us look at the advantages of being fuel-efficient, before we learn about different methods & equipment to help us do this.

Energy-efficient Cooking

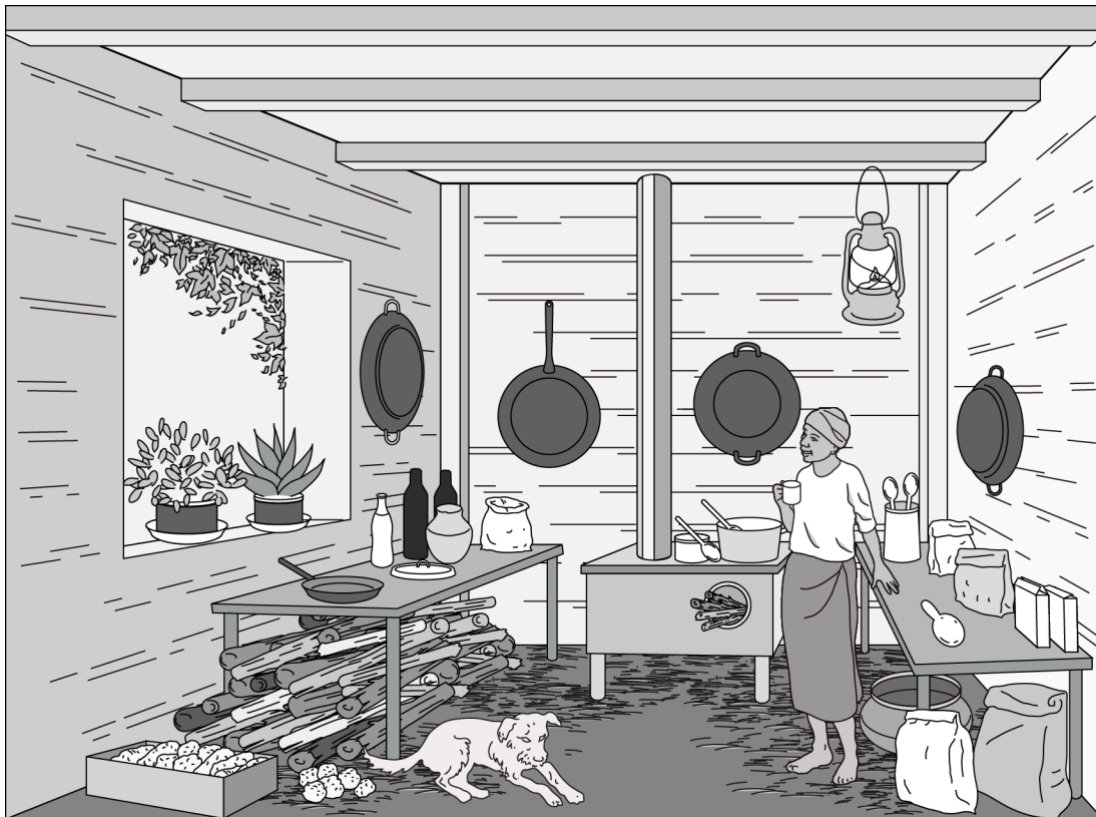

(Adapted from: *Improved Cook Stoves Manual – Peace Corps Bolivia 2008*)

- Well-designed stoves and kitchens produce less smoke, ash and air pollution
- People will be able to breath better and they will have fewer eye problems

- Fuel-efficient cooking often uses recycled waste (using paper charcoal, the sun, wind, manure for bio-gas, etc.) to fuel your home
- This helps to conserve trees and forest cover, looking after the environment and soil fertility at the same time
- Fuel-efficient cooking also reduces the use of other energy input, like electricity and human labour
- Less time is spent collecting firewood
- Less time is spent cooking (especially if you eat more raw foods like salads!)
- More time and money is available for other activities

Energy-efficient Cooking Habits

Eat raw foods: The less food is cooked the less fuel is used. Eating foods raw (those that are suitable to be eaten raw) saves time, energy, fuel and fewer nutrients are lost when food is not cooked.

Use methods of cooking that burn less fuel: efficient wood stoves, basket cookers, solar cookers, etc. Use other kinds of fuel, like paper charcoal, sunlight or bio-gas stoves. More information about these is coming right up!

Cover the pot! If there is no lid on the pot, lots of heat escapes and the food takes longer to cook. Covering the pot keeps the heat inside and reduces cooking time.

Soak beans: Beans can take 1-3 hours to soften by boiling. Soak the beans overnight the day before you want to cook them, or sprout them a few days before cooking. This reduces cooking time to one third of the usual time.

Fuel-efficient Wood Stoves

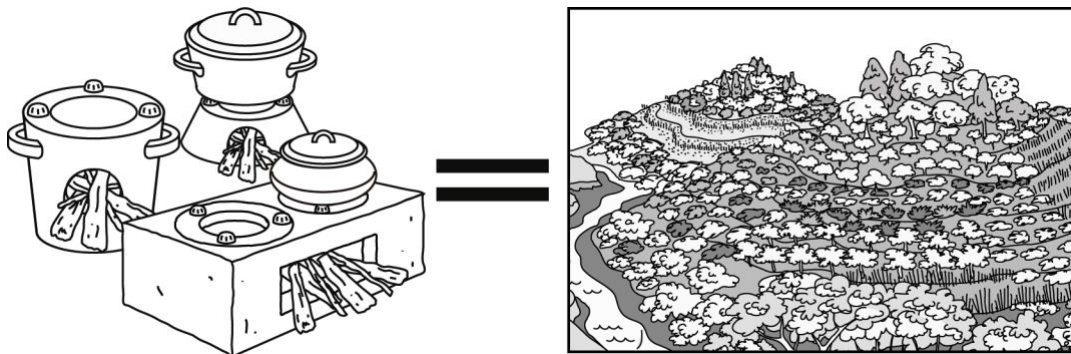

There are many styles of fuel-efficient wood stoves that can be made of metal or clay. They are often of simple design but have been designed with care, and a lot of thought, to manage three things:

Control the airflow

You need just enough air for the fire to burn. Too little and the fire goes out. Too much air and the fire burns too quickly. These stoves balance the amount of air correctly. Fires burn most efficiently if air flows from beneath the wood, up through the wood toward the centre of the pot. Fuel-efficient stoves often have three air holes: one under the wood, one on the side of the stove (which is optional), and then just enough gap between the stove and the pot for the air to exit. The air holes are often adjustable to manage different amounts of wind and different types of fuel.

Guide the flames

The flame's tips should hit the centre of the base of the pot. Any fire that goes around the edge is not being used efficiently. The heat just rises into the air, and does not go into the pot to cook your food.

Hold the heat

Stoves often have insulated walls for making the most of the heat for as long as possible. Why let it escape if you can use it more wisely?

Paper Charcoal “Briquettes”

Another way to use less wood is to burn something else instead. You can cook efficiently using waste paper if you make “paper logs” also known as “briquettes” to burn.



Gather waste paper

This can be any type of paper or cardboard that has been used in an office or school, from food packaging or other sorts of packaging.

If it was originally made from a tree then you can use it! (But it is best not to use very shiny paper or very colourful printed paper as these are both full of chemicals.)

Add dried leaves and grass if you do not have enough recycled (pre-used) paper. You can cut or tear the paper to speed up the next step.

Soak the paper

Put the paper in a container that can hold water such as a drum, bucket or pail.

The water does not have to be really clean as long as it is ok to touch with your hands. You can use water left over from washing dishes or clothes, or water harvested from your roof or collected from a river or well.

Soak the paper in water until it is soft. This will take a few hours or leave overnight. Thicker paper takes longer.





Make the paper logs

Make sizes and shapes that work for your kitchen. When the paper is soft, pull out a handful and squeeze the water out. Shape it into a variety of big and small balls and sticks.

Different shapes are useful for different situations so be diverse and try lots of shapes. (Some places in Malawi have machines to do this step quickly to make large amounts of paper briquettes.)

Let the paper briquettes dry

Choose an airy, sunny place. If you put them to dry on flat woven baskets (*lichero*) they can be moved around easily to follow the sun.

After 1-3 days they will have dried out (depending on the weather and the size of your paper logs).

The briquettes become much lighter when they are dry. Keep the paper logs dry in an old bag, box or basket until you need them.



Using paper briquettes

Paper briquettes need a bit more air to burn, compared to wood. If you are using a fuel-efficient stove have the air holes open wide.

Paper charcoal also works well in the open, on a 3-stone fire, if it is not a very windy day.

You may need to clean out the ash during cooking, depending on how long your meal takes to cook.



Paper briquettes produce more ash than cooking with wood, so use a type of stove that has holes for the ash to drop away from the fire. A typical charcoal '*mbaula*' in Malawi is a metal frame with a clay insert for the charcoal to sit on. The clay part has holes in it for ash to drop through, and there is adjustable ventilation.

Starting the paper briquettes takes a bit of practice. Begin a small, hot fire with little twigs and / or cardboard, using the small paper logs or break one of the paper logs into smaller pieces. (Do not use plastic to start your fires! This is a very unhealthy practice in Malawi because it pollutes the air.) When the fire is hot add the larger paper logs carefully so they do not put out the fire.

Cooking: Do not use the paper charcoal for grilling food because there may be chemical inks on the paper, which will get into your food. Because of the soft ash it is best to cook things in a covered pot, which is also more fuel-efficient. 10 paper balls (the size of an adult's hand) can burn from 30 minutes to an hour, depending on the stove and how the paper charcoal was made.

Insulated Basket Cookers / Coolers

Insulated baskets allow you to keep hot food and drinks hot or cold food and drinks cold. Whatever temperature your food / drinks are when you put them into the basket your insulated basket will keep them that way for hours. Insulated baskets save time and fuel because you do not have to keep feeding the fire, or running an expensive refrigerator, so you can go and do something else instead!

To make a basket cooker / cooler

Container

A large basket, container or sack that can hold your cooking pot / drinks with enough space for the insulating material all around it. The container does not have to be new, but it should be clean.

Insulation

Put clean, dry material in the bottom of the container and round the sides. This will hold the temperature steady in the container. The insulation should not be easy to melt and should be soft enough to fit close and snug around the food container you will put inside.

You can use dried grass or leaves (banana leaves work well), soft paper, scraps of cloth or even soft plastic stuffed inside a cloth liner. If you recycle soft, clean plastic bags as your insulation, be sure to have a strong layer of cloth or other material that will keep the hot pot from touching the plastic. If you are keeping things cold, recycled soft, clean plastic bags will work fine.

Leave a space in the middle of the insulation for the cooking pot. You can adjust the insulation to fit different sized pots or items and it should be packed tightly so that heat will not escape.

Cover

Some kind of insulated cover for the container so none of the heat can escape. An old sack or cloth will hold the dry material in place. The cover will be tucked into the inside edges of the insulated container to trap as much heat in as possible.

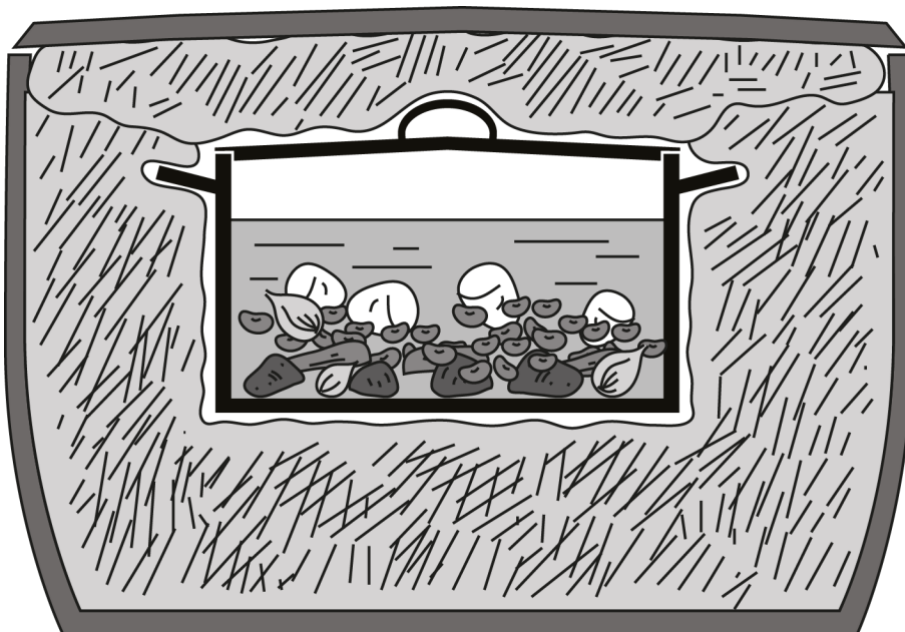

Using the insulated basket cooker / cooler

- For dried legumes, soak them overnight, and then cook for about 15 minutes.
- For grains, tubers or fresh legumes, cook for about 2-4 minutes.
- For cooled food and drinks, keep them in a refrigerator or freezer until you need to transport them in the insulated container.

Put the food or drink into the Insulated Basket. Remove the pot from the stove or item from the refrigerator / freezer and put it quickly into the insulated container and cover it. Tuck the cover into the insulated basket securely so the heat doesn't escape.

Wait while the food finishes cooking. The food will continue cooking and stay hot for about 6 hours.

- For dried legumes, wait at least 3 hours before opening the cover
- For grains, tubers or fresh legumes, wait 1 hour before opening the cover
- For cold items, they will stay cold for about 6 hours.

Solar Cookers

There is plenty of sunlight in Malawi and it is completely free! Why not use this sun for cooking? Solar cookers can be made from a wide range of materials and they are simple to use. They do not work at night or on very cloudy days though. Lots of sunlight is crucial! Find an outdoor spot that is sunny for several hours, that is not in a strong wind and where the food will be safe and clean.

Solar cookers work in three ways to catch light from the sun and convert it into heat:

- **Dark coloured pots** and materials absorb (hold) the heat. Dark surfaces get very hot in sunlight, but light surfaces reflect the sun and heat away. Food cooks best in dark, shallow, thin metal pots with dark, tight-fitting lids that hold in the heat and moisture. If you do not have a black pot, use the darkest colour you can find (or just use whatever pot you have).
- **Heat is trapped in a box-like structure** (often insulated) with a clear heat-resistant lid that lets sun in, or a strong plastic bag that keeps heat around the pot as long as possible.
- **Shiny, silvery panels direct the sun's hot rays** onto the pot. You can make a shiny surface with tin or use cardboard and cover it with anything silver, like aluminium foil, or the silver foil found inside several types of food packaging.

Solar cooker designs

- Box cookers
- Curved concentrators (parabolic)
- Panel cookers

There are hundreds of variations and Solar Cookers International share a lot of ideas and designs on their website. (See Part 3, Appendix 4 Acknowledgments)

Solar box cooker

These are the most common kind of solar cookers. An insulated box is made that will fit your cooking pots. The box can be made with cardboard or any other suitable material you can find. The box has double walls, which are stuffed with insulation (clean soft paper, plastic, cloth, cardboard, dried leaves or grass, etc.). The cooking container should be black and be shallow and wide enough for the sunlight to enter and hit most of the pot.

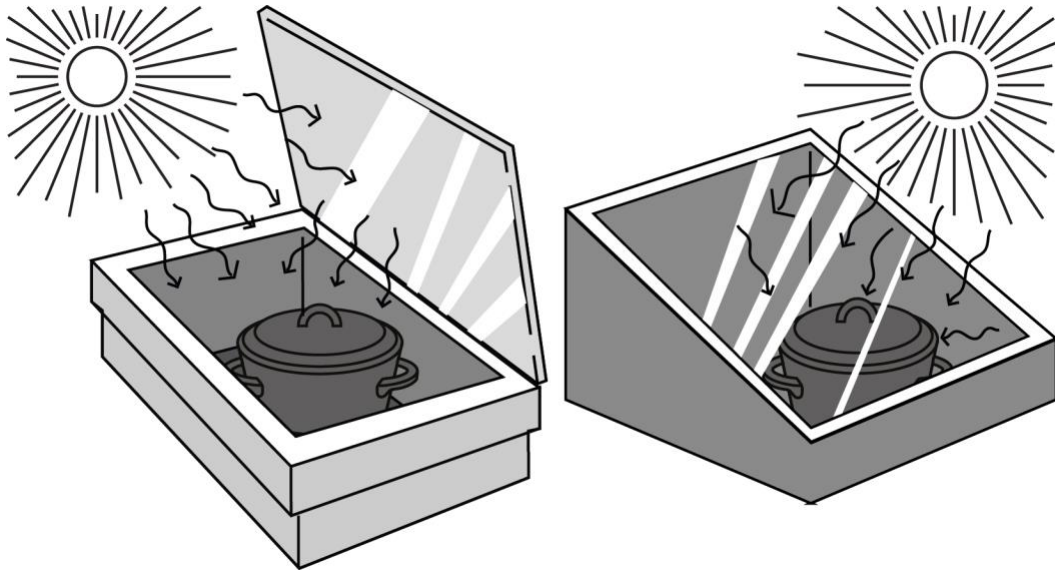

The top of the box is covered with glass or clear material that can allow sunlight to enter the box and trap heat. The inside of the box should be black, ideally, to absorb heat. An adjustable reflector can be attached to the top of the box to direct more heat and light onto the pot

Curved concentrator cookers

These **Parabolic** cookers cook very fast at high temperatures but require more input (effort and materials) to make the cooker.

They still can still be constructed with creative thinking. They are usually made with metal legs and pot-holder, and shiny metal for the curve (parabola).

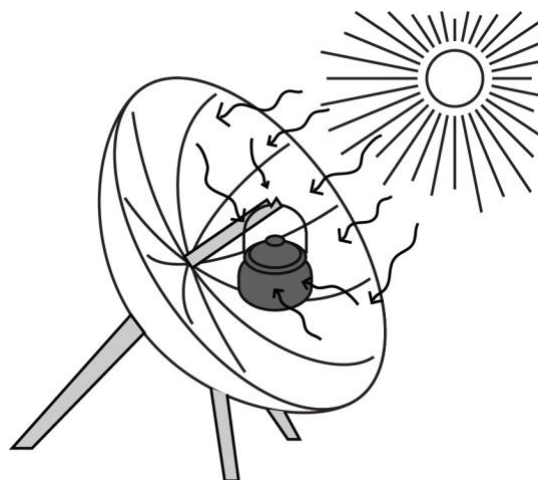

Panel cookers

These have elements of box and parabolic cookers. They are simple to make from many sorts of materials. There is a larger pattern you can copy on Poster 16 at the end of this part of the manual. Then follow the instructions given here.

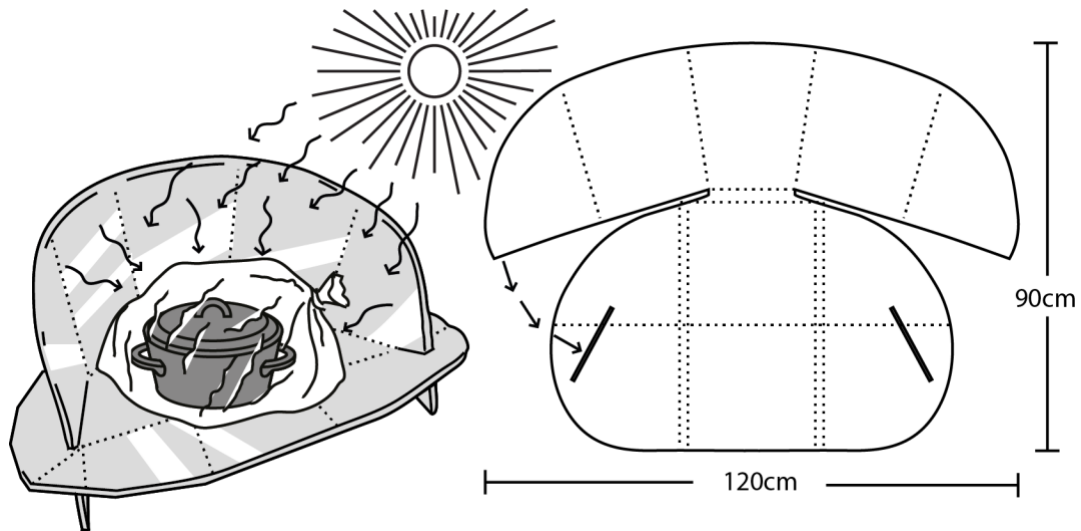

Using your solar cooker

Many types of food can be cooked in a solar cooker, and water can be disinfected (purified and sterilised so it is safe to drink).

- Start the cooking a bit earlier than usual...
- Use a dark pot
- For the panel cooker, put the pot in a clear tough plastic bag
- Place the pot in the cooker in direct sunlight
- Finish cooking the food while you relax or do something else!

Here is a general guide for cooking for cooking times for a family of five:

- 30 minutes to 1 hour for green vegetables
- 2-3 hours for *nsima*, rice, baking bread, fresh legumes (beans or nuts), small pieces of meat, sauces or soups, or cut up tubers
- 3-5 hours for dried legumes which have been soaked overnight, large pieces of meat or whole tubers
- One hour for every litre of water for SODIS (Solar Disinfection)

With a little practice, you can start cooking foods today without any fuel costs at all! And you do not have to stay by the food while it is cooking, so you will save your energy and time too.

You will find out how easy this is when you start using it with different recipes given later in this part of the manual.

Bio-gas Systems

Bio-gas is natural gas that is made when organic matter decomposes (to feed the Nature Cycle). Bio-gas is also what your body makes when you digest food, and you 'pass wind', commonly known as farting!

There is a lot of unused organic matter (especially manure) from humans and animals in Malawi. If we capture the gas we can use it for fuel. Any latrine or animal pen can be designed to produce fuel for cooking and lighting, with a bit of thought and planning.

There are already some bio-gas systems working in Malawi. There is a well-known system at Phwezi Secondary School in Rumphu, which has been working since the 1970s to fuel gas stoves for the kitchen.

The Department of Energy is keen to promote bio-gas systems and hopes to create examples in Lilongwe and Blantyre so that people can learn how to build their own systems. With 16 million people in Malawi and the numbers of animals increasing, this could be a lot of fuel and a lot of organic fertilizer!

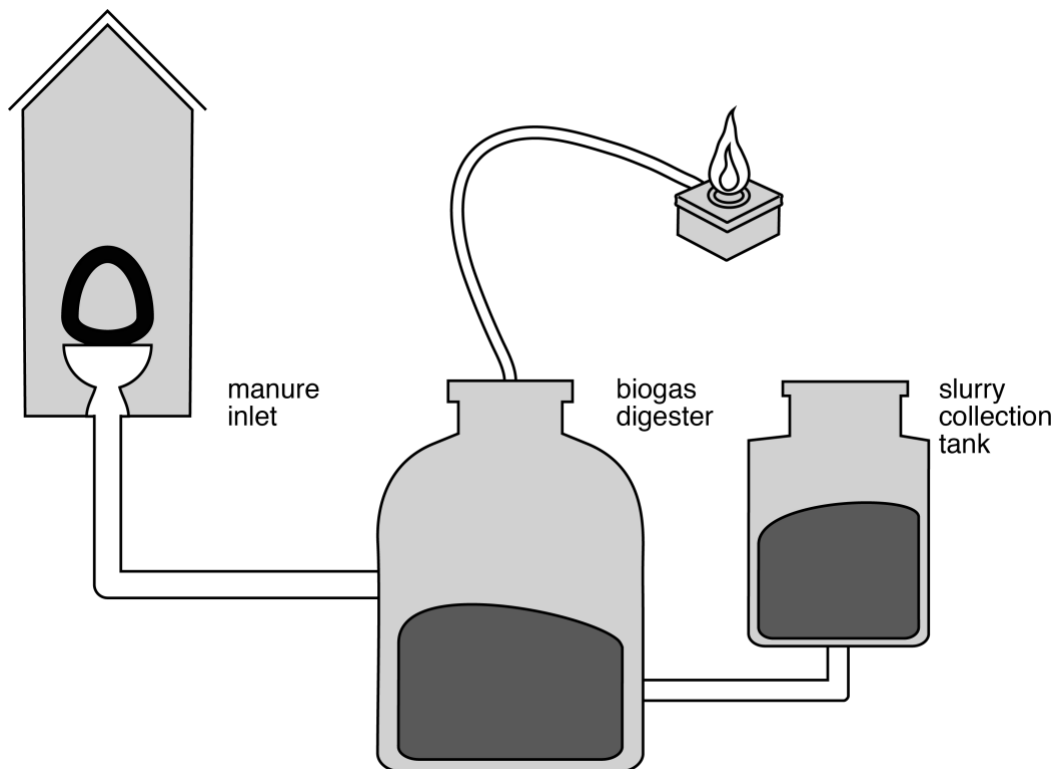

Organic matter (like manure and fresh plant scraps) is put into a 'digester'. Water is added. The digester works like a stomach to digest food. There are many different ways to put this material in the digester. It can be a part of the regular sewage system or there can be a door or opening to add the organic matter (then close it again so the gas does not escape). Organic matter should be added often so that gases are always being made. Water will need to be added too.

Decomposition makes gas. As the organic matter rots down and decomposes, gases rise to top part of the digester (the drum or pit). The gas is taken out of the digester through a pipe or hose so it can be used to power a gas stove, a gas lantern or a generator for electricity.

Organic fertilizer is what is left over. This is slurry and it is very good for the soil. As the organic matter rots and decomposes, it moves down to an area where it can be taken out and used as compost feed the soil.

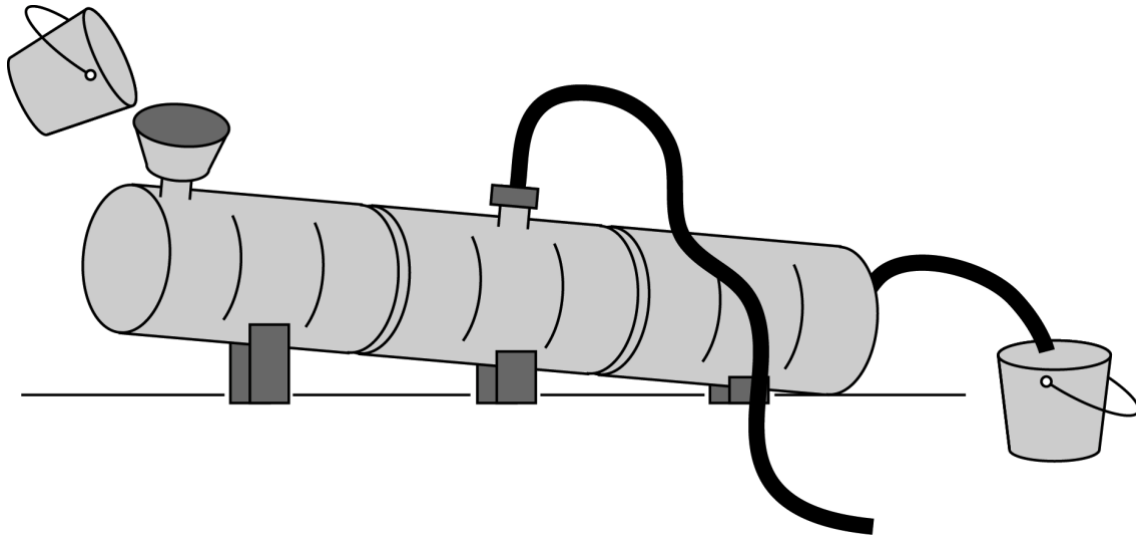

This picture shows a system made from 3 drums. The manure goes in at the top end, the gas rises and is taken away using the pipe in the middle, and the slurry is taken from the other end and used to enrich the soil and strengthen the Nature Cycle. The drums could be on a natural slope instead of a stand. The designs are endless!

Bio-fuels

Bio-fuels are different to bio-gas. Bio-fuels are usually fuels made from plant materials that are either rich in natural oils (like jatropha) or processed from plant material (for example, Malawi is increasing the production of ethanol, which is made from the by-products of sugar-cane processing).

A few places in Malawi have started working with bio-fuels but the practice is not widespread yet. There are organizations listed in Part 3, Appendix 4 with more information about this subject.



What energy sources are you using? Are they healthy for the earth and people? What resources could you be wasting that you could make use of?

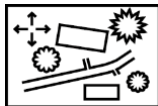

Look at your map and note where your cooking energy comes from. Note any other sources of energy that you already use, or could use, like sun, water or wind power?

Topic 13: Food Preservation and Storage

When we store food we need to make sure that it has as many nutrients as possible, and that it is stored safely so it does not make us ill. In Malawi foods are often dried in the sun on a mat on the ground for several days.

By the time it has dried out it has lost many of its nutrients. It might also have dirt and stones in it, and often insects and animals have got into it too. There are several ways to avoid these problems and store foods safely and healthily.



Storing Foods in the Environment

If you grow lots of different types of food, you can harvest different things all year long. You will be storing your foods the best way possible – where they are raised! This is better for the nutrient content of the foods, better for spacing out the work of harvesting and it is better for reducing the risk of food shortages.

If you can harvest food all year you do not need to save as much food in storage. Our ancestors preserved some foods, but they also ate what was in season. We can do this, too, by increasing the amount of diversity that we have available around us. (See the calendars for Foods Available by Group and Season in Part 3, Appendix 2.)

Preserving Foods for Future Use

When some foods are plentiful it makes good sense to preserve them for later use or so you can sell them for extra income. We will look at both long-term and short-term food preservation. There are several easy ways to make sure that germs do not spoil our food. There are two topics that we will apply here: Topic 8 on Protecting Nutrition and Topic 9 on Germs.

Cooling or freezing

This lowers the temperature of the food so it is too cold for germs to survive. Most people in Malawi do not have refrigerators or freezers but there are some other ways to keep foods cool for short periods that can be very useful.

Drying

Food can be preserved by removing all the water and drying the food out. This is a very good way of preserving foods in Malawi, where we have so much sunshine.

Pickling

This method makes sure that germs cannot grow because the food is put in a pickling solution that is high in sugars, salts and / or acid. Some germs can live without any air, but they cannot live in strong solutions of sugar, salt or acid (like vinegar). You need to follow the instructions carefully to have the right balance in your pickling solution and to use very hygienic methods.

If it isn't done right people can get sick from eating the foods. If it is done properly, the foods can still be good for eating for many months, even years.

Canning

This means heating the food quickly to kill the germs and then sealing the food inside jars or cans, so no other germs can get in. There are a few businesses in Malawi using this method. To can foods at home you need to be extremely careful. If it is appropriate for your situation, ask for more information from your District Food and Nutrition officer.

However, you choose to preserve your food you must remember to WASH! Remember that Water, Sanitation and Hygiene reduces the chances of germs growing in your food. Check your food carefully and use the best food safety practices every day to prevent food from getting spoiled.

Short Term Storage

Insulated basket cooler

The basket cooler uses exactly the same method as the insulated basket cooker / cooler (page 66), but you put in cold foods or drinks, and the insulation keeps everything cool for a few hours. These are great for field trips or long days away from home.

Root cellar

For roots, tubers and starchy fruits like bananas and plantains the traditional method of digging a pit in the earth and smearing it with clay, for cool, dry storage works well. (Some people design this right into their home, from the start.)

An evaporation cooler

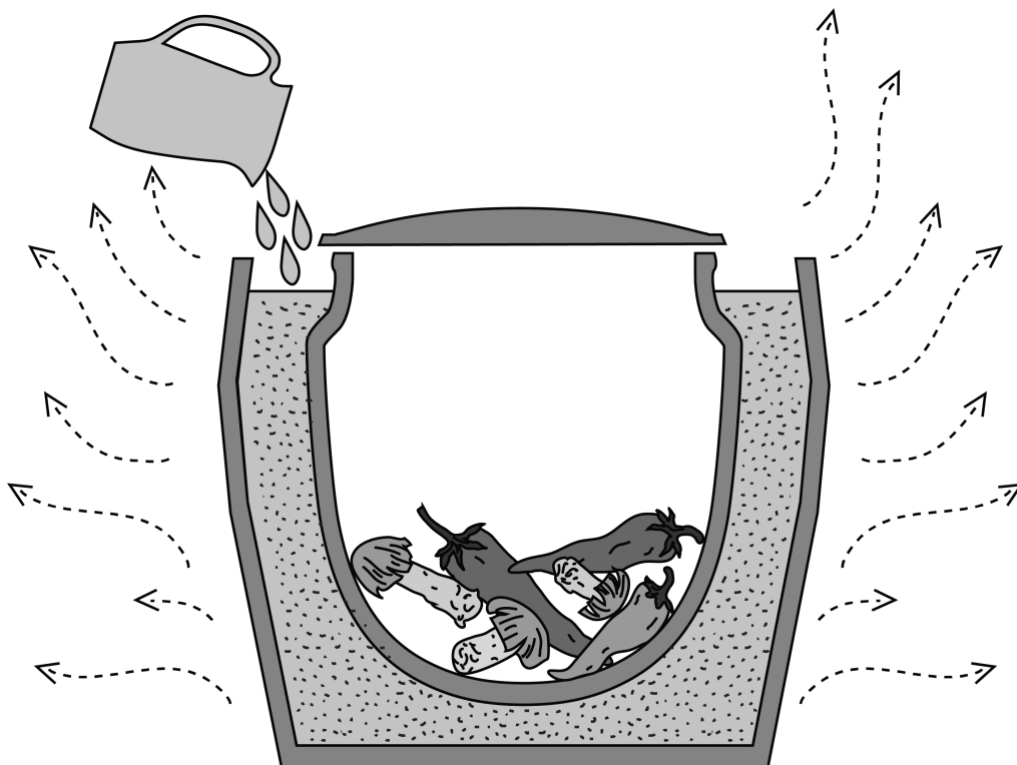

These are perfect for keeping fruits and vegetables fresh for several days. Water is added into clean sand that is between two clay pots and as the water evaporates out, the pots become cool. If you do not have pots, you can use any container or cloth that allows for evaporation. Be creative!

To make the cooler, a medium-sized clay pot is put inside a larger clay pot. Sand and water are put in the space between the pots.

Food is put in the central, smaller pot. A cover is put over the central pot to protect the food and keep it clean, but the outer pot needs to be left open to help the evaporation. As the wet sand evaporates it takes some of the heat away from the pots, just as when we sweat to cool off our bodies!

Long Term Storage

Solar drying

Solar drying is an easy, fast way to preserve food. It keeps the food clean and because it dries quickly, preserves more nutrients than foods dried in the open on the ground. When solar dried food is stored properly it can be saved for months.

Solar driers work by trapping the heat of the sun in a container with air flowing through the food to remove moisture. If there were no airflow the food would cook, like a solar cooker. There are many designs for solar dryers, but they all work similarly.

To make a solar dryer you'll need the following:

- **A container to hold the sun's heat.** The container could be as small as a bucket or as large as a room! It could be made of plywood, bamboo, woven baskets, brick, mud, metal, etc. It has to be something that you can put holes in for ventilation, or something that already has holes in. Use your imagination!
- **A clear plastic or glass lid.** This allows the sun in but keeps insects and dirt out. Some people use netting as a cover, but this only keeps insects out and it does not trap the heat so the drying takes longer.
- **Dark inside.** Black or dark colours absorb heat and keep the container hotter for longer. Some natural dyes can work, but think about the smell of whatever you use as it could affect the taste of the food being dried. Most importantly, make sure it is not poisonous!
- **Airflow.** If you raise the temperature inside the container it quickly draws the moisture out of the food and this hot, moist air needs somewhere to go or the food will cook. Vents on each side of the container will allow moist air to leave and new dry air to enter. Hot air rises, so put air vents low on one side and high on the other side. If the moisture forms water droplets on the lid and starts dripping back onto the food, you will need to adapt your design with more air holes or put less food into the dryer at once.
- **Food racks.** Racks are needed to hold the food in the dryer so that the air can move around the food as much as possible. Racks can be made of reed mats, screening, bamboo or any other material that can hold the food, that will not rust and will allow air to move around the food.

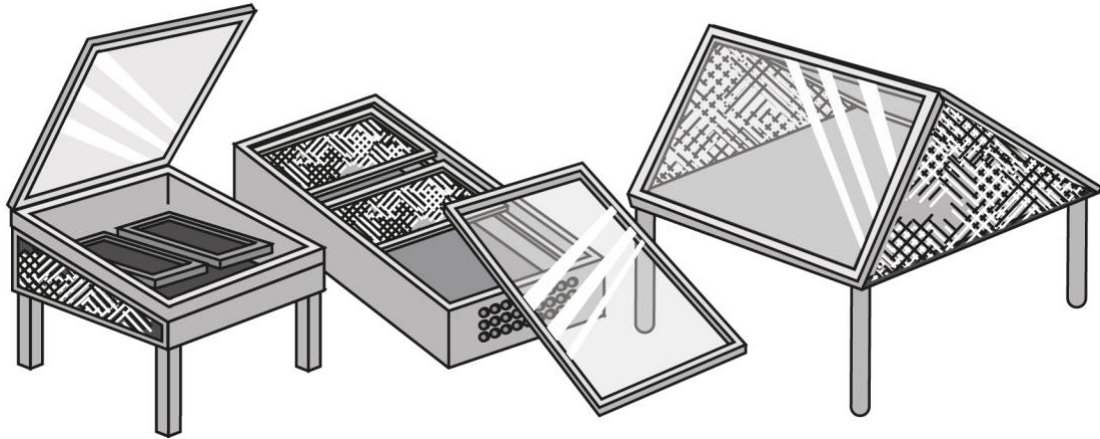

A box dryer is great for home use and for moving around easily from place to place to avoid rain and shade. You can put wheels on the bottom and handles on the outside for even better mobility. If you do not need to move it around you can put legs on it to make it easier to access the food and keep the food further off the ground.

An old tin bucket is perfect for a small solar dryer. Add a few small holes on either side for ventilation. Make a clear lid and a rack that fits inside and you have a very simple small solar drier!

A tandala can be adapted easily. A *tandala* is a traditional dish-drying rack in Malawi made with four poles with sticks tied across them to hold dishes.

- Make a clear plastic cover in the shape of a tent. If you do not have clear plastic you can use screening, cloth or other coloured plastic. Cloth will not let the sunlight in, but it can still trap some heat and keep the dust and animals away.
- Use a woven mat as a rack.
- Lastly, add screening to cover the ends of the tent. If you do not have screening use the same material you used to make the tent cover.

Drying grains, legumes and oil-seeds

Seeds can be dried whole, de-husked or shelled to get them ready for storage, depending on the species and your needs. Separate out any spoiled seeds and only preserve the good ones. The solar dryer helps increase the strength of the heat, which dries the foods quickly and kills any germs or insects hiding in the food.

Drying fruits, vegetables and tubers

These have more water in them when they are harvested and often need more care and additional processing before they are dried. Each species is different and whole books are written just on drying. These general tips will get you started:

- **Select produce that is just ripe and still firm.** For example, if you use over-ripe fruits the high sugar content can turn them black (such as tomatoes from the vegetable group or mangoes from the fruit group).
- **Start with clean food, water, people and working areas.** These should be without dirt, dust, flies, insects or animals. Clean the produce according to its species. Most will need to be washed in clean water. Some can be scrubbed, especially if you are going to eat roots and tubers, others may need to be peeled.
- **There are nutrients in the skins so think before you peel!** Some foods dry better when they are peeled like papayas, mangos, bananas, pumpkins, onions, cassava, and yams. Other foods are better dried with the peels on, like tomatoes, carrots, eggplant, apples, gooseberries, sweet and Irish potatoes.

Slice foods before drying them

The size of the slices will depend on what the food is. Some foods dry well whole, such as small tubers, berries, small onions, dark green leaves, herbs and cloves of garlic.

- Foods should be cut to about the same size so they take the same amount of time to dry. Large pieces dry more slowly. Firm, hard foods like pumpkin, roots or tubers can be grated to help them dry quickly.
- The more water in the food the more it shrinks when it dries. Tomatoes and melons need to be sliced thickly (1-2 cm) since they have a lot of water. They will dry to about half the original size, or even less. Moist fruits and fruit vegetables should be sliced about 1-2 cm thick to allow for shrinkage.
- Some foods, like bananas, apples and tubers, turn brown when cut. They stay white if you dip them in citrus juice (lemon, lime, orange, grapefruit, etc.) or in honey before drying.
- Leaves and herbs can be dried then crumbled or powdered after they are dry.
- Onions, potatoes, pumpkins, carrots and other soup vegetables can all be cut into small pieces before drying and then combined to make 'instant' soup mixes, camping meals, or ready-mixed flavouring packets.

Put the foods on the rack

Put the same sized pieces of food on one tray so that all the food on the tray is finished at the same time. You can have several types of food at once, or only one type of food in the dryer, but you do not want moisture from one food to get into a food that is almost dry.

Drying times will vary

The more water content a food has the longer it will take to dry. The strength of the sun will vary but if it is hotter and drier the drying will be quicker. Breezy weather is generally quicker than still air. With this in mind you can expect:

- 2-3 days drying for dense or moist items like mangoes, bananas, tomatoes or apples. You will still be able to bend the fruits when they are done.
- 1-2 days for onions, papayas, peppers and mushrooms
- 1 day or less for green vegetables / herbs. They can sometimes be done in just a few hours. Leaves will be crisp and crumbly when they are dry.
- To test if the food is well dried, put the dried food in a plastic bag. If no moisture collects in the bag after a few hours, they are probably dry.
- Enjoy now or store away for the future, they can last for several months to years.

Storage containers

Pack dried foods in clean, airtight packaging so that moisture, germs and insects cannot get in. Reused clean glass jars, covered clay pots, sacks, plastic containers, zip-lock bags, or food packaging like used bread bags. Make sure that whatever you choose is clean and closes.

For dried vegetables, teas, or spices paper bags or 'breathable' containers work well. A '*chikwatu*' container made of tree leaves and natural string fibres, hung from the ceiling or a shelf, is a great traditional solution and very sustainable (if people keep planting trees!).

Keep your dried food in a cool, dry place. These foods last over a year when dried and stored properly! Check your food stores regularly to make sure there is no

Part 1, Topic 13: **Food Preservation and Storage**

moisture forming on the glass or plastic, no insects or any other signs that the food is being damaged or disturbed.

First in, first out. Always use the oldest items in storage first to reduce the chance of food loss.

Use surplus foods to make some extra income. There may be a lot of money to be made! Look in shops for ideas: herbal teas, spices, soup mixes, dried fruits, pumpkin seeds, pickled mangoes, condiments, fruits juices, etc. Malawians do not make many of these so there are opportunities there.

We need to start being creative with our products and concentrate on quality. Nearly all the products on our shelves could come from local producers. Buy Malawian whenever you can!



Are you preserving and storing enough food? Are you doing it well?
Could you do it better?



Note on your map the different places where food is stored (the maize store, the kitchen, a root cellar etc.)

Topic 14: Creative Cooking

Using food well is the third pillar of Food Security. Food security's three pillars are: availability, accessibility and utilization. (See page 20.) This means: are all the food groups available? Can you get foods from all the food groups (grow it or buy it)? And do you know how to use foods from all the food groups?

Anyone who eats should know how to prepare healthy food – male or female, young or old. Even very young children can help out in the kitchen. People who take part in preparing food and understand nutrition are often more willing to try new things.

Even if you do not prepare your own food often, you need to know the basics of how to follow and create recipes. If you have read this far you already know more than most people about diet, digestion, health and nutrition, food groups, hygiene, planning and preparation, kitchen design and efficient energy use. Well done!

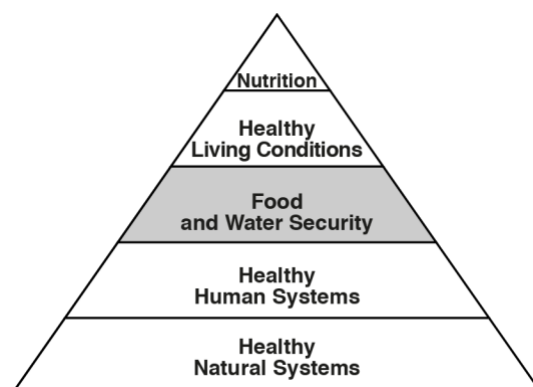

Start Cooking Creatively!

Now you have the tools you need to start on a creative cooking adventure. The idea of being creative is to understand that there are many options to any recipe. You can adapt just about any recipe with what you have available, or use healthier choices when adapting a recipe you already have.

The recipes listed here are easy to follow and adapt and include hints on measuring different foods, suggestions for using different ingredients, local foods and cooking supplies. The more you adapt to what is available in your area, the easier it will be to get diversity into your diet, and there are ideas for every food group.

The quantities are given in teaspoons, tablespoons and cups. They are approximate measures so it does not matter if you use a spoon a little bit smaller or larger than someone else.

Tsp. = teaspoon

This is a really small spoon that holds about 5ml of liquids or 3 to 5 grams of dry goods (like ground spices, flour, salt etc.)

Tbsp. = Tablespoon

This is a larger spoon that holds 10-15ml of liquid or 6 to 15 grams of dry food (two or three times what a teaspoon holds)

c = cup

A cup holds about 250 ml of liquid or 130-200 grams of dried food. Different foods weigh different amounts. For example, a cup of flour weighs about 130 grams, but a cup of sugar, which is heavier than flour, weighs about 200 grams.

Add ingredients to taste. When a recipe says 'add salt or pepper to taste' it means to your taste. So add a little, taste the food, and decide if you need a little more or not. (If you use a clean finger or clean spoon to taste the food, do not put it back in the pot! If you do this you add your germs to the food.)

Personalise your recipes. Make notes in the spaces round the recipes when you try other ingredients or adjust the recipe. You might make the recipe for lots of people, or you might try it with different ingredients.

Good recipes are free if you ask around and watch what other people do with food. There are plenty of books, TV shows and websites about food from all over the world. Some shops in Malawi's cities might have second-hand cook-books for sale, but it is hard to get hold of books about Malawian cooking.

Share your experiences with others as you adapt recipes and use local ingredients. Not everyone can read this book so if you are reading this, you could help others who cannot read as well as you. Male and female, adults and children, all should be encouraged to enjoy Creative Cooking and learn to understand and value the importance of food. Eating is much more fun when you understand what cooking is all about!

Recipes for Each Food Group

Staples

- Tortillas or Chapattis
- Perfectly Easy Whole-grains (using a basket cooker)
- Pasta
- Pasta Salad

Fruits

- Juices, Smoothies & Milkshakes
- Mango Chutney
- Mango Salsa
- Jam

Vegetables

- Stir Fry
- Sprouts
- Veggie Burgers, Balls or Patties
- Mixed *Ndiwo* (or Soup)

Legumes & Nuts

- Bean Salad
- Roasted Soy Beans

Animal Foods

- Frittata (or Omelette)
- Pickled Eggs (or Vegetables)
- Chitipa Cheese

Fats & Oils

- Pumpkin Seeds
- Guacamole

Staple Food Recipes

Flour usually refers to wheat, but flours can be made with many different starchy foods such as other grains like sorghum, millet, rice, etc.

Starchy roots like cassava, sweet potato, Irish potato, yams, etc. can also make flour, as can legumes or nuts like soy, groundnut, cowpeas, pigeon peas, etc. Grains can often be swapped with each other. Use sorghum instead of rice for example.

Whole-grains are best as they still have the germ and bran. They take longer to cook but are better for you and take less processing before cooking.

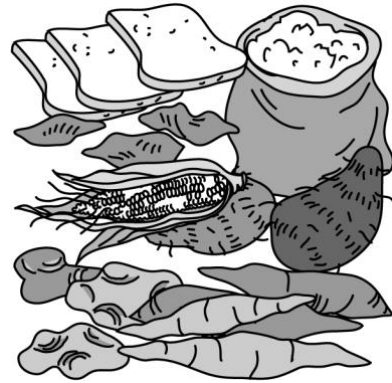

Serves 2 to 4	Tortillas or Chapattis
<p>These are flat breads that come from South America and India. They are simple to make and are simply delicious with all kinds of other foods!</p>	
<p>2 c flour (any) 1 tsp. salt $\frac{3}{4}$ c water $\frac{1}{4}$ c oil</p>	<ol style="list-style-type: none"> 1. Mix the flour and salt in a bowl. Most flours, or mixtures of flours, will work such as maize, wheat, millet, cassava, etc. 2. Add the water and oil and mix well. You may need to add a little more water or flour to adjust the dough, so that it is not too sticky to work with. You can let the dough sit for 30-60 minutes to come together before the next step. 3. Take about 2 tablespoons of the dough and make it into a round ball. Roll it out thinly on a floured surface. 4. Fry the tortilla in a hot, dry pan. You do not need to add oil to the pan, but some people prefer to.
<p>Food Groups: Staples, Fats + other food group that you choose.</p>	
<p>Serve with: You can eat all sorts of other foods with this. Try them filled with the following:</p> <ul style="list-style-type: none"> • Beans and/or ground beef, and salad for a main meal. • Guacamole and tomato salad for a good lunch. • Chopped green salad, sliced tomato and small chunks of cheese. • Mixed chopped vegetable fried up with a bit of fish • Or try them with fruit, jam or honey and cinnamon for a sweet treat. 	
<p>Variations:</p> <ul style="list-style-type: none"> • You can vary the oil to water ratio, as long as there is enough liquid for the dough. • Adding about 1 tsp. of baking powder to the recipe creates a softer tortilla • The spices depend on what else you are serving with the tortillas. 	

Serves 2 - 4	Perfectly Easy Whole Grains
<p>Cook your grains in an insulated basket cooker Instead of boiling, which uses a lot of firewood. It will be perfectly cooked and cannot possibly burn! (See page 66 if you cannot remember the details of how to make an insulated cooker.)</p> <p>Boiled rice is often cooked in Malawi, but sorghum, millet or wheat are also tasty boiled as a staple for your <i>ndiwo</i> (meat, legume, and / or vegetable dish). You can mix grains together to give rice a new twist, or you can add other food groups to the pot to make a one-pot meal.</p> <p>Harder grains take longer to cook, so add them in stages with the hardest ones added first. Whole-grains have the most nutrients. This is when the germ and bran are kept during processing (i.e. only the husk is removed).</p>	
<p>2 c whole-grains</p> <p>2 c water</p> <p>¼ c spices, vegetables, herbs</p> <p>¼ c nuts (peanuts, cashews)</p> <p>¼ c oilseeds (pumpkin, sunflowers)</p>	<ol style="list-style-type: none"> 1. Get your insulated basket. Check that the padding fits tightly and that you have a lid for the pot and a cover for the cooker. 2. Clean and chop spices, vegetables, herbs, nuts or seeds so you can add them quickly later. 3. Measure the grains and put them in separate dishes, ready to add to the boiling water. Place them in order by cooking time so the harder grains go into the pot first: <ul style="list-style-type: none"> - Sorghum, brown rice, Wheat: 5 minutes for basket cooking, 30 minutes if just cooking with the stove. - White rice, millet: 2 minutes for basket / 20 min just stove. 4. Measure the same number of cups of water as cups of grains. Put the water into a cooking pot and bring to a boil. 5. When water is boiling, add hardest grains first and boil for 3 minutes (or 10 minutes for stove). <ul style="list-style-type: none"> - Then add the softer grains and boil another 2 minutes (20 minutes for stove). If you are adding other ingredients, add them after about 1 minute (10 minutes for stove) such as the chopped vegetables, herbs, spices and nuts. Cover the pot and heat it briefly, just to get it hot again, or to do its final cooking on the stove. 6. Remove the covered pot from the stove and put it into the basket cooker straight away, covering it quickly with the lid and the insulated cover. 7. Let it stand in the basket cooker for at least 30-45 minutes. Or, let it stand longer - it will stay hot for 6-8 hours if left in the insulated basket, and it won't overcook.
<p>Food Groups: Staples, plus other groups you choose (Legumes, Vegetables, Fats)</p>	

Serves 2	Pasta
<p>This is quick to make and tastes great with different toppings. Pasta is from Italy, but the Italians got the idea from Chinese noodles. Eat it hot with a tomato or meat sauce, with stir-fried vegetables or serve it cold as a salad.</p>	
<p>1 c of flour ½ tsp. salt 1 egg 2 Tbsp. milk</p>	<ol style="list-style-type: none"> 1. Mix the flour (many types of flour can work) and salt. Make a small well in the centre of the dry mix. 2. Beat the egg and milk together. Pour the egg and milk mix into the dry ingredients. Slowly mix together. Use your hands to mix when it gets stiff. 3. Place the pasta dough on a floured surface and roll it into a thin sheet. Dust it with flour and let it stand for a few minutes. 4. Roll the sheet up like a poster and slice it with a knife. Unroll the pasta strips and gather loosely together. 5. Drop the strips into boiling water for 3 - 5 minutes. 6. Drain and add your choice of topping or relish.
<p>Food Groups: Staples, plus toppings of food from Animal Foods, Legumes & Nuts, Vegetables or Fats</p>	
<p>Variations:</p> <ul style="list-style-type: none"> • Try replacing a quarter or half of the wheat flour with other flours like rice, sorghum, maize or a starchy roots flour (potato, yam, cassava). • Pureed vegetables like spinach or greens are good mixed into the pasta dough. • Black pepper, basil, garlic, onion or other spices may be added to the flour for flavour and nutrients. • Add oil or butter with the milk and egg to make it richer, or use water instead of milk to make it lower in calories. • Add finely chopped / crushed herbs for extra taste and nutrition. 	

Serves 2	Pasta Salad
<p>An easy, satisfying salad with lots of contrasting tastes and textures. The pasta is filling, the dressing is delicious and the chopped vegetables are nice and crunchy.</p>	
<p>2 c cooked pasta ½ c onion ½ c tomato ¼ c green pepper 1 Tbs. garlic 1 Tbs. sesame seeds 1 lime 1-2 tsp. of oil</p>	<ol style="list-style-type: none"> 1. Cool freshly cooked pasta by rinsing it with cold water after it has been boiled. Drain it and put it in a large bowl. Add a few drops of oil to stop it from sticking together. 2. Chop the garlic very finely. Chop all the vegetables and add to the pasta. Amounts can be varied as much as you like. Add sesame seeds. 3. For the dressing (the sauce) squeeze the lime juice into a bowl and add about the same amount of oil and a little salt. 4. Experiment with adding spices or herbs to the salad such as chillies, black pepper or basil.
<p>Food Groups: Staples, Vegetables, Animal Foods, Fats</p>	
<p>Variations:</p> <ul style="list-style-type: none"> • Use any vegetables or salad, green herbs, fresh or dry peppers, mayonnaise instead of oil. • Reduce the amount of oil for less energy, increase it for more. • Add cooked beans and / or an animal food. • Add protein with sliced boiled eggs, or cut and crumbled cheese. 	

Fruit Recipes

Fruits are often eaten raw as they are harvested from the tree, bush or vine, but there are many other things you can do with fruit.

Fruit Smoothies and fruity Milk Shake: Blend any different fruits into a thick drink, adding water if needed to make it more liquid. Add honey for extra sweetness if you need to. Remove inedible peels and seeds before blending.

Small edible seeds can be included, such as watermelon, strawberries or *chisale*. Edible skins, such as apple skins, can be included as they add vitamins, minerals and fibre. Make your smoothie with milk to add proteins, fats, vitamins and minerals for a richer, more powerful drink. Smoothies are great for people trying to gain weight.

Jams or Preserves: Using sugar or salt create a fruit dish that can keep for many months without spoiling – even without a refrigerator.

Dried Fruit: Works well for firm fruits, but if you are creative you can dry just about anything!

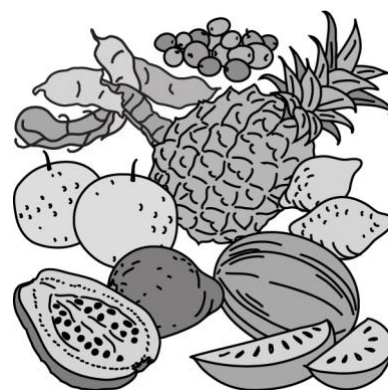

Serves several	Fruit Juices	
Many fruits can be juiced and real fruit juices are so much better than refined sugar drinks! (Avoid squashes and sodas.) Make or buy juice and use honey instead of sugar. Some juices are heated to get the flavours out of the fruit; others can be made cold.		
Heated	Hibiscus (<i>chidede</i>)	This is made like a tea, using the hibiscus 'calyx'
Heated or cold	Baobab (<i>malambe</i>) Camel's foot (<i>chisale</i>)	Mix powder with water, making a paste with the power first, can help make mixing easy. <i>Chisale</i> pods can be powdered whole (with skin and seeds as well).
Squeezed	Any citrus fruits	Just squeeze the juice out!
Smoothie	Banana, papaya, pineapple, melon, peach, citrus fruit etc.	Smash /crush/blend the fruit whole; add some water or milk to smooth it if needed.

Serves several	Mango Chutney	
This is a great way to use mangoes and the fruitiness of this chutney goes well with staples and with nearly everything that needs a little bit of something sweet and spicy!		
¼ c onion ½ c red pepper ½ c sugar ½ c raisins ⅓ c vinegar 3 c chopped mangoes	<ol style="list-style-type: none"> 1. Chop the onions and crush the red pepper. Combine all ingredients in a pan. Put the lid on and bring to the boil then lower the heat. 2. Take the lid off and simmer for 15 minutes stirring occasionally. Add salt and pepper to taste if desired. 3. Stir in mangoes. Heat through and then let it cool down. (The mangoes do not need to cook very much). 4. Pack in clean, covered containers and it can keep for months. 	
Food Groups: Fruits, Vegetables		
Serve with: <ul style="list-style-type: none"> • Use as a condiment with tortillas, sandwiches, rice dishes and salads. 		
Variations: <ul style="list-style-type: none"> • Garlic and ginger are good additions during the boiling stage. • You can add other fruits instead of raisins or mangoes. 		

Makes 2 cups	Mango Salsa	
This is another good use of mangoes. The shredded lime peel gives this an interesting bitter-sweet taste, which is good with lots of different foods.		
1 or 2 mangoes 1 sweet pepper 1 small onion 1 chilli pepper ½ tsp. lime juice ½ tsp. lime peel 3 Tbsp. oil 1 Tbsp. vinegar	<ol style="list-style-type: none"> 1. Thinly slice the mangoes (leave the skin on for extra nutrients). 2. Chop the peppers, onions and chilli. 3. Shred or grate the lime peel. (Cut it in very thin strips, as thin as you can.) 4. Mix all the other ingredients with the chopped mango and vegetables. Add any other spices of your choice. 5. If you have time, let it sit for at least 15 minutes before serving so the flavours come together. 	
Food Groups: Fruits, Vegetables		
Serve with: Tortillas, sandwiches, meat, or beans		
Variations: Good as a dip, with chunks of grilled or toasted bread, and goes well with salads too. Try making this with other firm fruit instead of mangoes.		

Serves several	Jam	
Jam is an easy way to preserve fruits that you have lots of, and it is a nice treat to eat with breads or pancakes. Making and selling jam can be a good way to earn extra income.		
1 c of fruit 1 c of sugar The juice of half a lemon	<ol style="list-style-type: none"> 1. Choose firm fruit and discard any brown parts. Wash, peel, and de-seed the fruit. Cut roughly into small pieces. Put the fruit in a pan and cover with water. Cover the pan and leave to stand for a few hours or overnight. The next day bring it to the boil and cook gently till the fruit is tender. 2. Measure how many cups full of the fruit/juice there are. For each cup of fruit add 1 cup of sugar and the juice of ½ a lemon. 3. Stir the jam over a gentle heat until the sugar is dissolved. Then bring to a fast boil, uncovered, and keep boiling until the jam has reached 'setting point'. To test for the setting point, stir the jam well then let the last drop from the spoon fall on a cold plate. As it cools, push the drop gently with a finger. If it crinkles, the setting point has been reached. 4. Set the pan aside to cool down a bit before bottling the jam. This helps prevent the fruit from floating to the top of the jam jar as it cools. Put the jam in very clean, hot jars, covered with an airtight layer of clean thin plastic (cut from a sugar bag or similar) or a layer of candle wax and then seal the bottles. When they have cooled, wipe the bottles clean (with a clean wet cloth), label them and store in a cool dark place. 	
Food Groups: Fruits		
Variations: <ul style="list-style-type: none"> • Any fruit can be made into jam, but you need to practise. Start with small quantities! • Softer fruit needs less water added and less cooking. • When you get really good and start selling wonderful jams you can ask customers to bring their own clean containers and sell them the jam by the cupful. This would help keep your costs down and your profits up! 		

Vegetable Recipes

Cooked vegetables should keep their colour and some crispness. Keep the cooking time short to keep the most nutrients.

Even better - don't cook - create salads!

Many vegetables can be, and should be, eaten raw. Just mix together any combination of fresh, clean, chopped vegetables in a bowl and eat them. Simple! Vegetables that can be eaten raw include:

- Almost all green leafy vegetables
- Root vegetables such as onions and garlic
- Fruit vegetables such as tomatoes, cucumbers
- Many types of mushrooms



Raw vegetable salads are good with added nuts, oil seeds and a bit of oil and lemon juice. Some people like to add fruits or cooked meats / fish / beans or pieces of cheese. There are many different variations for salads. Use the bean salad recipe as a guide.

Serves 4	Stir-fry
Stir-fry just means to fry quickly with very little oil on high heat. A stir-fry has so many options! Lots of varied healthy vegetables, lots of flavours and lots of room to adapt with what you have available in any season.	
½ c okra 1 c green pepper 1 c onion 1 c tomato 2 c greens 2 c cabbage 2 Tbs. garlic 1 -2 Tbs. oil	<ol style="list-style-type: none"> 1. Chop up all the vegetables. (Larger pieces will keep more of their nutrients but take longer to cook.) 2. Heat oil in frying pan. Add the slower cooking vegetables first (green pepper & okra). 3. Cook 2-3 minutes, stirring occasionally, then add onion and cook for 2-3 mins more until it begins to go brown. (The brown adds lots of flavour). 4. Add tomatoes, greens and garlic, cover and cook for another 2-3 minutes. The water in the tomatoes will steam the greens. Vegetables should keep their colour and some crispness.
Food Groups: Vegetables, and other food groups	
Serve with: Rice, rice and millet or pasta, or tortillas.	
Variations: Anything you think will taste nice! Local greens, eggplant, carrots, loofa (sponge or <i>chinkupule</i>), cucumber, sprouts etc. are all good; <i>nsinjiro</i> , roasted nuts, edible seeds, peanut butter or peanut flour, meat, scrambled eggs, chicken, fish, etc. Reduce or increase oil, depending on the energy needed. Use different flavours of oil: sesame, pumpkin, gourds. Most herbs and spices will be good with this, especially basil, coriander (cilantro), pepper, peri-peri, soy sauce, etc.	

Serves any number	Sprouts
<p>Bean sprouts can be made from any seed that is edible raw. 'Sprouting' is when you let the seed start growing a little shoot an inch or two long. (This is called germination.) Then you eat it all, seed and stem. There are a lot of nutrients in this stage of growth. Bean sprouts can be eaten raw or cooked.</p>	
<p>½ c dry seed per person makes about 1 c of bean sprouts</p> <ul style="list-style-type: none"> • Mung bean (<i>pphodza</i>) • Soybean • Pigeon peas (<i>nandolo</i>) • Green peas (<i>sawawa</i>) • Chick peas (<i>nchana</i>) • Groundnuts (<i>mtedza</i>) • Amaranth seeds (<i>bonongwe</i>) • Mustard seeds (<i>mpiru</i>) • Fenugreek • Sunflower seeds • Sesame seeds (<i>chitowe</i>) • etc. 	<ol style="list-style-type: none"> 1. If the seeds are dry soak them overnight. Fresh seeds (like fresh legumes) do not need to be soaked. The next day drain off the water and use it for cooking or use it to water your plants, as there are lots of nutrients in the water. 2. To germinate the seeds need a balance between moisture, airflow and medium temperature, not too hot or too cold. If it is too wet, too hot or there is too little air the seeds will rot. If it is too dry and too cold the seeds will not grow. Some options are: <ul style="list-style-type: none"> - Pile the seeds in a <i>lichero</i> (flat winnowing basket) and cover them with large thick leaves like coco yam or banana leaves. Leave them covered for a few days until they sprout. - Or... put them in a container and cover it with a clean cloth (cotton or mesh is best). Put the container in a dark place. Rinse and drain the seeds 2-3 times a day. 3. Small seeds begin to sprout in 2-3 days. When the sprouts have reached the desired length bring them out into a sunny spot and they will turn bright green. 4. Bean sprouts can last from a few days to a week if kept in a cool place and rinsed every day. 5. To always have a supply of sprouts start a new batch once a week.
<p>Food Groups: Vegetables</p>	
<ul style="list-style-type: none"> • Serve with: Eat them raw in a salad or add them to a stir-fry or vegetable stew. 	
<p>Variations:</p> <ul style="list-style-type: none"> • Bean sprouts on their own have a lovely fresh flavour and need nothing else! • Choose spices to go with the other foods for a good meal. 	

Serves 4	Veggie Burgers, Balls or Patties
<p>These patties have many different variations. They can be made with different food bases: vegetables, legumes, staples and different shapes. You can hear them called by many different names: Veggie Burgers, Bean Burgers, Potato Patties, Rice Patties, Pumpkin Patties, Veggie Balls, Bean Balls etc. You get the idea! Get creative and come up with names for your own favourites!</p>	
<p>2 c of the 'base' food, like pumpkin, potatoes or rice</p> <p>1 egg</p> <p>½ c flour</p> <p>½ Tbsp. baking powder</p> <p>¼ c any vegetables</p> <p>½ tsp. salt</p> <p>2 Tbsp. oil for frying</p> <p>Add pepper, herbs or spices to taste</p>	<ol style="list-style-type: none"> 1. Cook 2 cups of the 'base' food, or use leftovers. Cut the food up into bite-sized pieces or mash it. Rice or beans are suitable un-mashed. 2. Beat egg and add to the food base and mix well. 3. Mix together flour, salt and baking powder. Add to the base mixture and stir. 4. Add other vegetables and herbs: green leafy veg, onions, garlic, peppers, tomatoes etc. Add nuts or oilseeds if you like. Add them whole, chopped, crushed or powered. 5. Mix together well. You want to get it to a consistency that holds together well. If the mixture is too soft add a little flour. If it is too stiff add a tiny bit of water, milk or other liquid. 6. Take a few spoonfuls of the mixture and make into patties or balls. 7. Fry carefully in hot oil till brown on both sides, turning once during frying. Smaller patties are easier to fry. Be gentle with them. They are delicate little patties!
<p>Food Groups: Staples, Animal foods, vegetables, fats (Legumes if added)</p>	
<p>Serve with: Eat these really fresh and hot, with a tomato salad and some bread for lunch or with root vegetables and <i>ndiwo</i> for the evening meal. So many different foods can be used!</p>	
<p>Variations:</p> <ul style="list-style-type: none"> • Add 1-2 Tbsp. of the following for extra flavour: peanut flour, peanut butter, honey, cinnamon and nutmeg. Use any flour to make the patties (legume, grain, root) • Baking powder is optional. It helps keep them light but works without it. 	

Serves 2	Mixed <i>Ndiwo</i> or Soup	
This is the most adaptable recipe ever! Mixed <i>ndiwo</i> can be any combination of foods that you like and think will taste good together. Use any foods that are in season in your area. Try lots of different combinations and discover surprising tastes!		
1 or 3 c water ½ c grain or 1 c 1 c vegetables; greens, garlic, onion, gourd, etc. ½ c cooked beans ¼ c flour 3 Tbsp. oil ½ c milk or <i>chambiko</i>	<ol style="list-style-type: none"> 1. Put the water in a pot. For a soup add more liquid (2-3 cups) to make a thicker dish use less water (1 cup) 2. Add ½ cup of grain or 1 cup of any tuber and allow to cook until almost soft, 10-15 minutes. 3. Chop all the vegetables and herbs. Add vegetables, herbs and cooked beans and cook for another 2-5 minutes. 4. Add milk, cream or <i>chambiko</i> to the mixture if desired. See variation for thicker cream soup below. 5. Cook until the staple food is soft. Add more water if needed, or add a little flour to thicken it and then stir. 	
Food Groups: Staples, Vegetables and whichever other groups are added		
Serve with: <ul style="list-style-type: none"> • A staple like <i>nsima</i>, rice or sweet potato as an <i>ndiwo</i> if it is thick. • Bread and a salad if you have made it into soup. 		
Variations: <ul style="list-style-type: none"> • Adding chopped tomato makes this into a lovely sauce to go with pasta. • Use any staple: roots, rice, maize, millet, sorghum etc. • Use any vegetables; greens, eggplant, pumpkin, carrots, local vegetables, etc. • Use any herbs / spices: basil, salt, pepper or chilli. • Use a variety of legumes: pigeon peas, bambara nut etc. • Add cooked meat, fish or poultry with the staple. Add nut flour (<i>nsinjiro</i>) when adding the vegetables. For a creamy soup: mix flour and fat together in a cup or bowl until it is a paste. Slowly add milk or yogurt to the paste, stirring constantly until well mixed. Slowly add this mixture to the soup as the last ingredient (after vegetables, herbs, beans) and mix in well. 		

Legumes & Nut recipes

There have been foods from this group in some of the other recipes already, wrapped into a tortilla / chapatti, in with grains or as a side dish, as part of a pasta sauce or in a pasta salad, in a stir fry, sprouted or in a mixed *ndiwo* / soup. Legumes and nuts are a superb source of a wide variety of nutrients so include them in your diet every day!

Many nuts can be eaten just toasted, or, as is typically done in Malawi, made into a flour (*ufa*) and added to baked foods or *ndiwo* during the cooking process.

Most legumes need to be cooked, some are even poisonous raw, so make sure you know your legumes and cook them properly!



Serves 4	Bean Salad
<p>There is a lot of protein in this tangy, tasty salad and it is easy and quick to make – perfect for leftover beans. It is very similar to the pasta salad, but without the pasta!</p>	
<p>2 c of beans (cooked) 1 onion 1 green pepper ¼ c of oil ½ c vinegar ½ c lemon juice (or lime or vinegar) 1-3 Tbsp. of crushed garlic</p>	<ol style="list-style-type: none"> 1. Put the cooked beans into a large salad bowl. 2. Cut up the vegetables (onions, green pepper and herbs) to your desired size. Crush or chop the garlic. 3. Mix onions, pepper, garlic, oil and lemon juice into the beans 4. Add salt and black / hot pepper if you like to taste. 5. Allow the salad to sit (rest) for a while before eating for the best flavour. (Remember to cover it to stop insects getting your food).
<p>Food Groups: Legumes, Vegetables, Fats</p>	
<p>Serve with: Hot meals, other salads or sandwiches for a filling healthy lunch.</p>	
<p>Variations:</p> <ul style="list-style-type: none"> • You can use any type of cooked bean. A little bit of honey / sugar is good to balance the sharp flavours (lime / vinegar / veg / beans). • A wide variety of greens or herbs can be used: basil (<i>mpungabwe</i>), chives, onion or garlic greens, marjoram, parsley (<i>kanzota / mbilidzongwe</i>) • Add a cold cooked staple, grain, or cooked and cubed starchy root, to make it a full meal. Add cheese or yogurt, or cubed cooked meats. • This recipe guide also works well for any type of salad: such as vegetable salad, staple salad or egg salad. 	

Serves 1	Roasted Soy Beans	
<p>A really crunchy, tasty, wholesome snack. Use more beans if you need to make larger amounts. A handful of these is great with a packed lunch. It adds protein and fibre to any meal. A whole bowl full is good to share on social occasions with friends.</p>		
<p>¼ to ½ c soy beans per person</p> <p>Salt, peri-peri or other spices can be added.</p>	<ol style="list-style-type: none"> 1. Clean the soybeans and put them in a thick frying pan or clay pot. 2. Toast them slowly without adding oil. Stir often to prevent burning. 3. When ready to eat they will turn light brown and crack open a little bit. 4. Let them cool a little or completely before eating. 	
<p>Food Groups: Legumes</p>		
<p>Serve with: Eat these with a meal or with sandwiches for lunch.</p>		
<p>Variations:</p> <ul style="list-style-type: none"> • The beans can be boiled first, drained well and then toasted. 		

Animal Food Recipes

This is another food group, like legumes and nuts, which we have integrated into the other recipes as we go along. Animal foods (food from animals) are under-used in much of Malawi, especially eggs and milk.

These are highlighted in the following recipes. In other parts of Malawi, as well as wealthier areas of the world, animal foods are over-used. No one needs very much from this food group, so just remember to enjoy moderation!



Makes varied amounts	Frittata (or Omelette)
This egg dish is based on Spanish, Italian or French cooking, depending on the ingredients you add and the methods you use.	
8 eggs per person 1 c vegetables 2 Tbsp. oil Basil, salt, pepper, and local spices would all be good with this dish.	<ol style="list-style-type: none"> 1. Chop vegetables into bite size pieces. 2. Beat the eggs in a bowl and add the vegetables. 3. Put oil in a thick frying pan and put on low heat. Add the egg mixture, cover the pan and cook very slowly. If this cooks slowly enough and stays covered it should not have to be turned over. Cook for about 20 min covered, or until cooked through.
Food Groups: Animal foods, Vegetables, Fat	
Serve: Hot with a staple (bread, potatoes or grain) and a salad or cooked vegetable.	
Variations: <ul style="list-style-type: none"> • Omelette: instead of mixing the eggs and vegetables together, stir-fry the vegetables and set aside. Beat 2 eggs (per person) and pour into a small frying pan, cook on one or both sides, depending on your preference. Add stir-fry to half of one side of the cooked egg so that you can flip the other side over the vegetables so that it is wrapped in the middle of the egg. • Use any vegetables: Onion, garlic, greens, mushroom, eggplant, tomato etc. Add animals foods: cut up / shredded cheese, meats, fish, chicken • Staples: tubers or grains – these will take longer to cook when included and you may need to add some water or milk to the beaten egg 	

Makes 12 eggs	Pickled Eggs (or Vegetables)
<p>This is good as a snack or with other food for a meal. These eggs can be stored for a few weeks to a few months. This recipe has come from Norway.</p>	
<p>12 eggs, (or other food to be pickled) 2 c chopped onions 2 c vinegar ½ c water 1 c sugar 1 Tbsp. salt</p> <p>Any combination of spices, like garlic, peri-peri, coriander, basil</p>	<ol style="list-style-type: none"> 1. First hard-boil the eggs: Put the eggs in a pan of water over high heat. Bring the water to the boil. When it is bubbling start timing the cooking. Boil the eggs for 6 minutes. Lift the eggs out of the hot water and rinse them in some cool water. 2. Slice the onions into large slices, whatever size you prefer. 3. Peel the hard-boiled eggs and place them in a clean, sterilized (boiled / heated) pickling jar, alternating onions and eggs. 4. Put the vinegar, water, sugar and salt in a pan. (This is the pickling liquid that preserves the eggs and keeps them safe. You should not change the proportions of these ingredients.) 5. Add whatever spices you want to the pickling liquid. 6. Boil the spiced pickling liquid for 10 minutes. 7. Pour the pickling liquid into the pickling jar over the hard-boiled eggs and sliced onions. When cooled enough, put the lid on the jar so that it seals tightly so no germs can get in. 8. Leave the eggs a few days (or months) before eating so they take on the flavours of the spices.
<p>Food Groups: Animal foods, Vegetables</p>	
<p>Serve with: These make great side dishes to go with the main meal or with a packed lunch.</p>	
<p>Variations: Many, many foods can be pickled this way: cucumbers, green peppers, carrots, okra, etc.</p>	

Makes 1 cup	Chitipa Cheese	
<p>This is a mild, soft, crumbly or creamy cheese depending on how much liquid you drain out of it. For a crumblier cheese let most of the water dry out of the cheese. This is Malawi's version but people all over the world make cheeses in different ways for different textures and flavours. It is a great way to make milk last for a few days longer than it would as just milk.</p>		
<p>4 c milk (goat, cow, sheep) ½ Tbsp. citric acid (lemon, lime etc.) 2 tsp. salt garlic, Italian spices, garlic chives, peri-peri</p>	<ol style="list-style-type: none"> 1. Heat the milk to almost boiling while stirring constantly – but do not let it bubble. 2. Remove from heat and wait 5 minutes so it cools down a bit. 3. Stir in the citric acid (lemon, lime, vinegar, or test out different options). 4. Stir until milk starts to 'curdle' (separates into different parts!) 5. Let the milk sit for 30 minutes until it separates into a fluffy white solid (curds) and a pale yellow liquid (whey). The curds will become the cheese. 6. Slowly, pour the mixture through a very clean cotton cloth into a clean container, large enough to hold the whey. The cloth will catch the curds and the whey will pass through. There are nutrients in the whey so you should use it as a drink or in any of the recipes that call for water (soup, <i>ndiwo</i>) or for watering your plants, worm farm or compost it. 7. When drained a little, add salt into the curds. You can add other spices or herbs now, as well. 8. Wrap the salted / spiced cheese in the cloth and hang it up to continue draining and drying as long as you wish. You can, however, eat it as it is! 	
<p>Food Groups: Animal foods</p>		
<p>Serve with: Sandwiches, or with salads, or mixed into a mashed staple food, or use it as a dip with crackers or fresh vegetable sticks.</p>		
<p>Variations:</p> <ul style="list-style-type: none"> • Add vegetables, herbs or spices when adding salt, such as basil, chives, hot pepper, garlic, onions. • Use vinegar as a curdling agent instead of citric acid. 		

Fats and Oils Recipes

Malawi has a lot of edible oil seeds and fruit-fats (coconut and avocado) that are very under-used.

This food group should be used in the smallest quantities. It has already been used in almost every other recipe.



Serves 1	Pumpkin Seeds
<p>This is cooked the same way as the roasted soy beans. Roast seeds make a lunch time snack more nutritious, and a handful is great if you feel hungry but the meal time is a long time away. It is a traditional American snack. Roast lots of seeds to share with friends!</p>	
<p>¼ c pumpkin seeds per person Salt if wanted</p>	<ol style="list-style-type: none"> 1. Toast them slowly in a thick hot frying pan / clay pot / on a tray in an oven until golden brown 2. Stir them often to stop them burning.
<p>Food Groups: Fats</p>	
<p>Variations:</p> <ul style="list-style-type: none"> • Any edible seeds, like sunflower seeds, or melon seeds. • Peri-peri goes well with pumpkin seeds, as do many other spices. 	

Serves 4	Guacamole
<p>A lovely rich creamy spread from Mexico, which is warm with spices and cool to the taste at the same time! It is so easy to make...</p>	
<p>1 large avocado 1 large tomato 2 small onion 2 cloves garlic 2 Tbsp. lemon juice 1 tsp. salt 1 red chilli</p>	<ol style="list-style-type: none"> 1. Mash avocado with lemon juice. 2. Grind the red chilli to a powder (or chop small if fresh) and mix with the avocado. 3. Chop the rest of the ingredients very small and mix with the avocado. 4. Add salt to your taste. 5. Serve with tortillas, sandwiches, bread or salads
<p>Food Groups: Fats, vegetables</p>	
<p>Variations:</p> <ul style="list-style-type: none"> • Add other crisp, crunchy vegetables like chopped cucumber, red or green sweet peppers etc. • The herb cilantro (coriander leaves) is a great with this if available. 	

Congratulations! On to Part 2!

Now you have learned about your body, your digestive system, and nutrition. You know about the importance of a balanced diet, the Six Food Groups and what different foods and nutrients do to keep you healthy and strong.

It's time to look at the world around you and find out about the Nature Cycle, the Water Cycle and how soil works to provide everything we need for our lives.

Part 2 of the manual is about Healthy Environments and you will learn how to keep soil healthy, how to protect and improve the fertility of the soil so that your gardens and fields give good yields. Your journey toward sustainable living and a healthy future has just started!

Posters to Copy and Display

The last few pages of this book contain posters covering all the main subjects in the Manual for Sustainable Nutrition. You can photocopy these or draw them yourself and put them on the wall. This will help you and others to think about the subjects covered and thinking is an important part of successfully designing for Sustainable Nutrition.

Poster 1	The Digestive System
Poster 2	The Nutrient Village
Poster 3	Current and Better Meals
Poster 4	The Six Food Groups
Poster 5	Meals and Snacks
Poster 6	The Nature Cycle
Poster 7	Soil Formation
Poster 8	Compost
Poster 9	The Water Cycle
Poster 10	The Water Table
Poster 11	Permaculture Zones
Poster 12	Zone 1 Garden
Poster 13	Zone 2 Orchard
Poster 14	Zone 3 Fields
Poster 15	Zone 4 Managed Forests
Poster 16	Solar Panel Cooker Pattern

The Human Digestive System

Poster 1

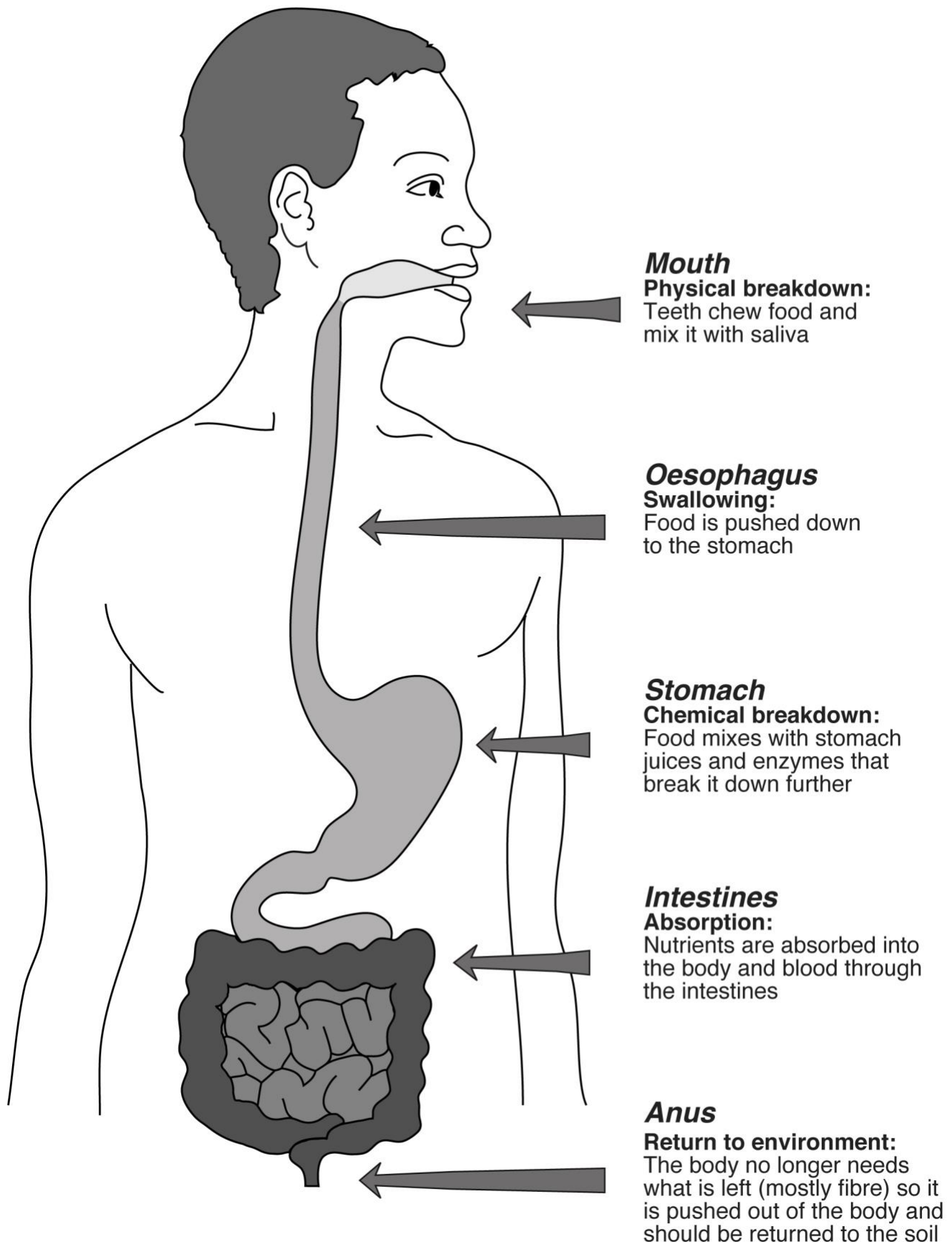

The Nutrient Village

Poster 2

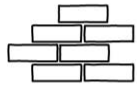

Proteins
Are the building blocks of life



Minerals
Join the parts of the body together



Carbohydrates
Provide fuel for energy



Fats
Provide fuel for energy



Vitamins
Give protection from illness



Water
Washes and cleans the body inside and out

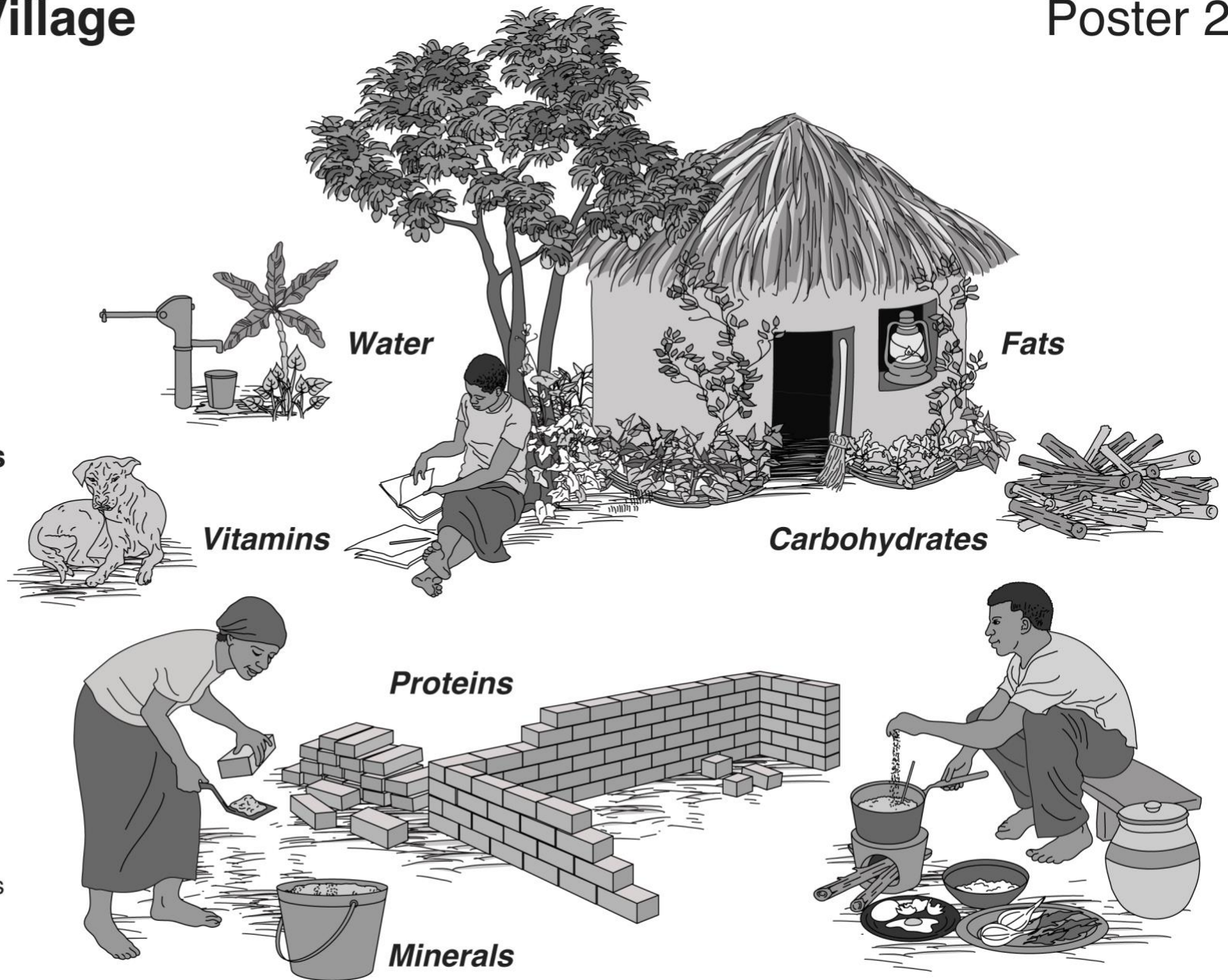

Water

Fats

Vitamins

Carbohydrates

Proteins

Minerals

The Current Meal

Poster 3

Similar problems worldwide....

- Few nutrients
- Monoculture
- High risk of crop failure
- High risk of food insecurity
- Environmental degradation
- High input



The Better Meal

Similar solutions world-wide too!

- Many nutrients
- Diverse agriculture
- Increased chance of harvests
- Increased food security
- Healthy environment
- Fewer inputs



Malawi's Six Food Groups

Poster 4

So many choices to create a balanced diet!

Foods are grouped together because they contain similar nutrients

All foods are different so eat a variety from each of the food groups every day

Drink plenty of water! 3 to 4 litres a day for an adult in a hot country. It has minerals as well as the water your body needs

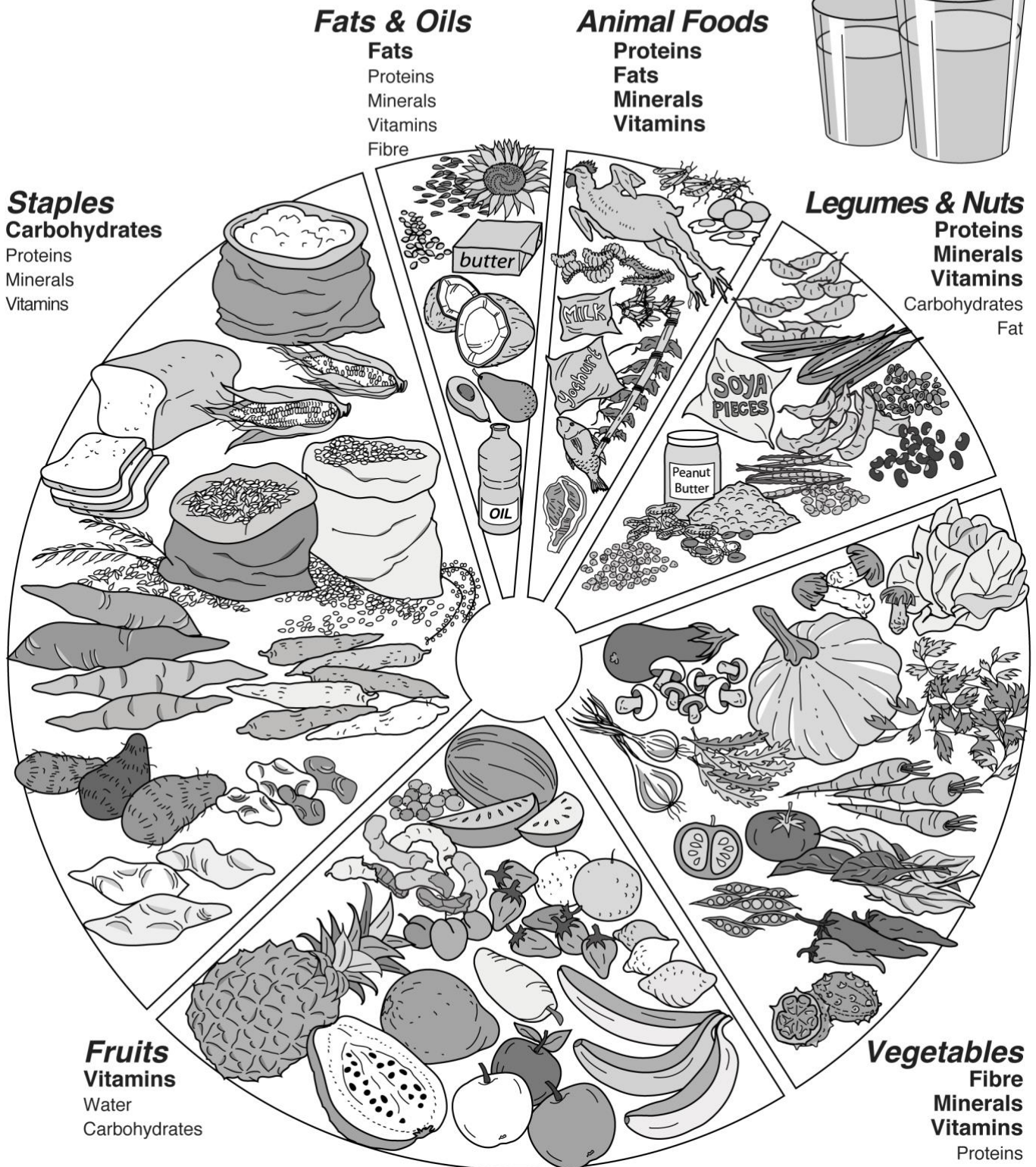
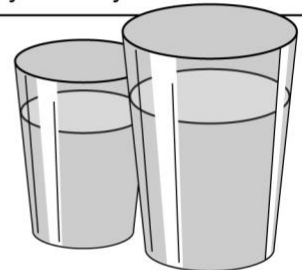

Meals and Snacks

Poster 5

Current Choices

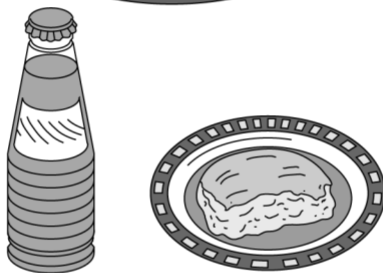
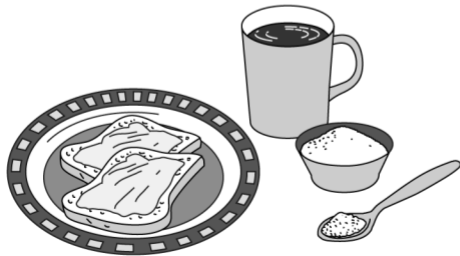
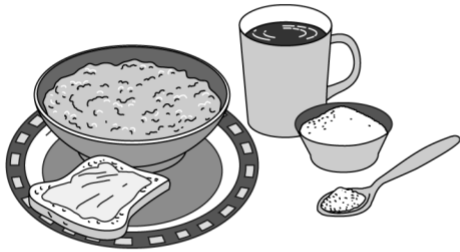

Better Choices

Breakfast



Snack

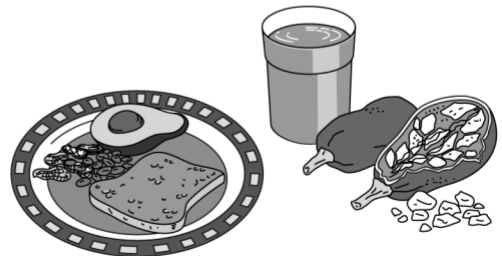

Lunch



Snack

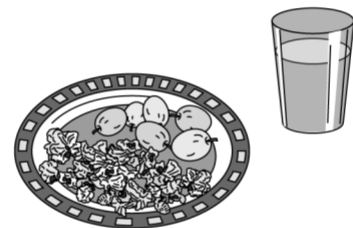

Supper



The Nature Cycle

Poster 6

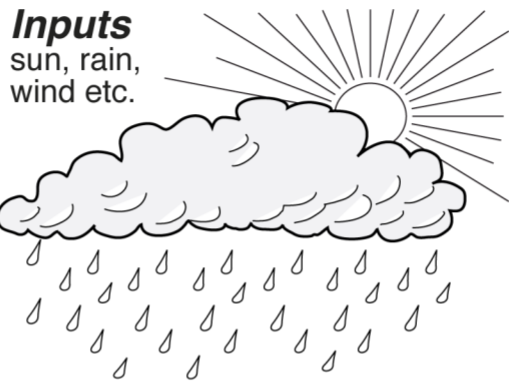

Use
Foods and raw materials
are used by living things
including people

Death
Living things die
and enter the ground

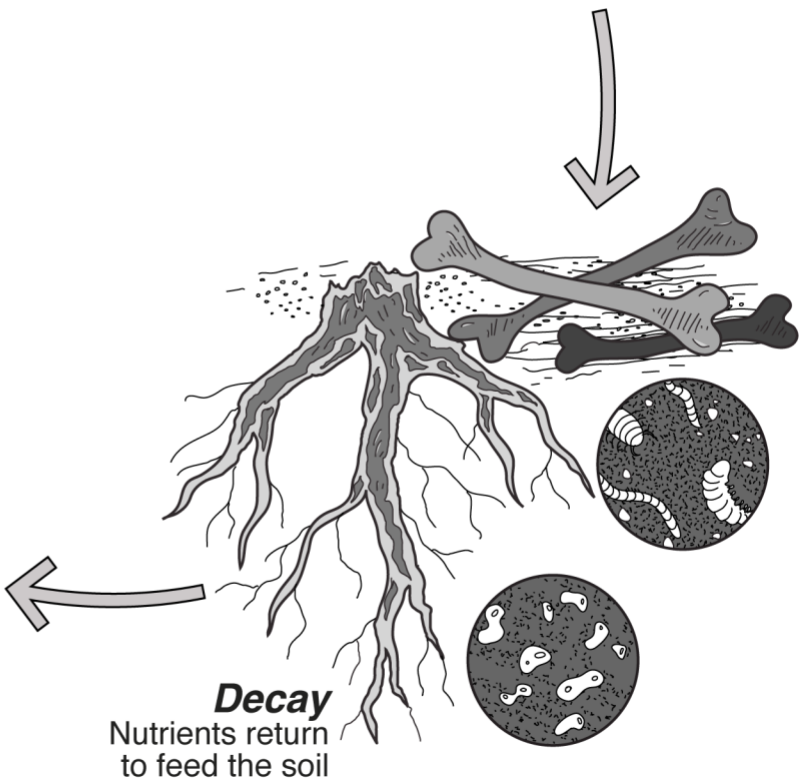
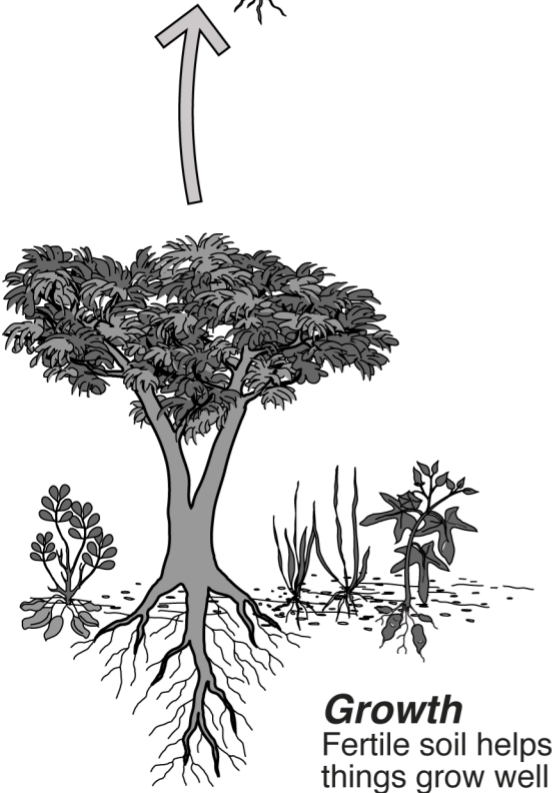
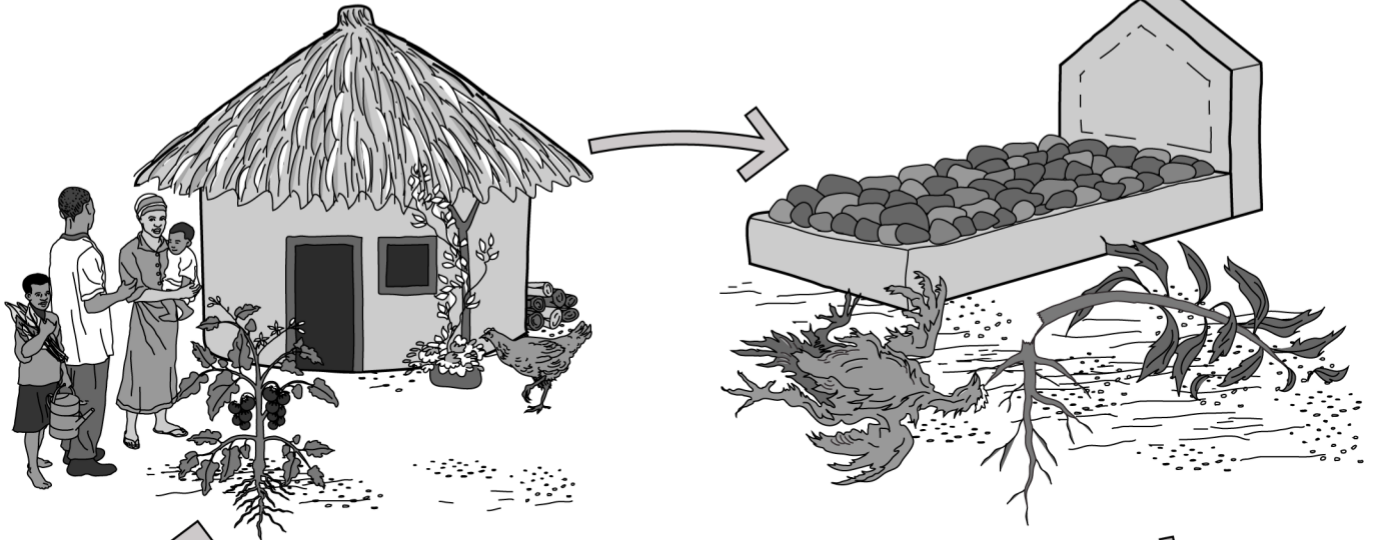

Soil Formation

Poster 7

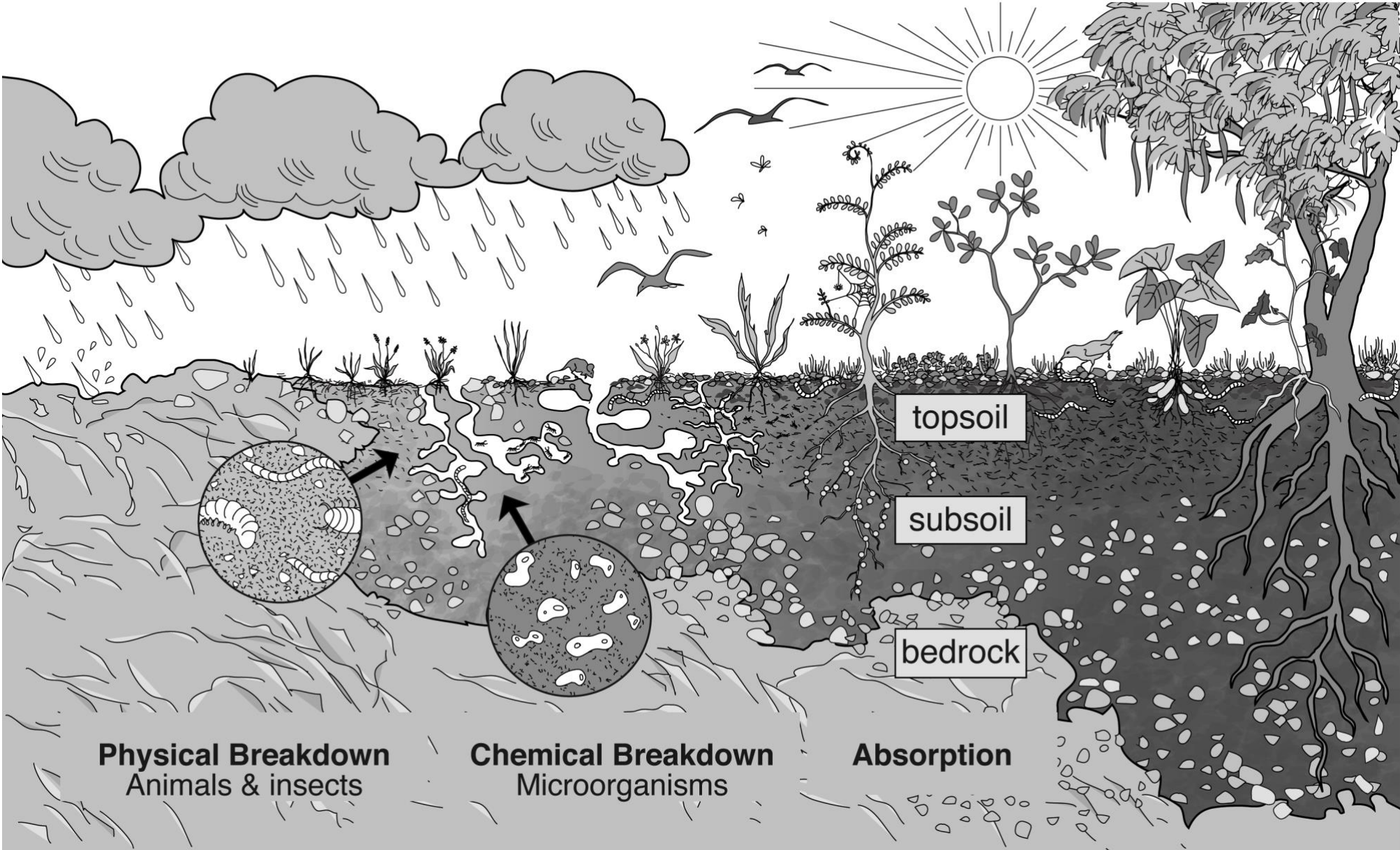

Compost

Poster 8

Nature's Digestive System

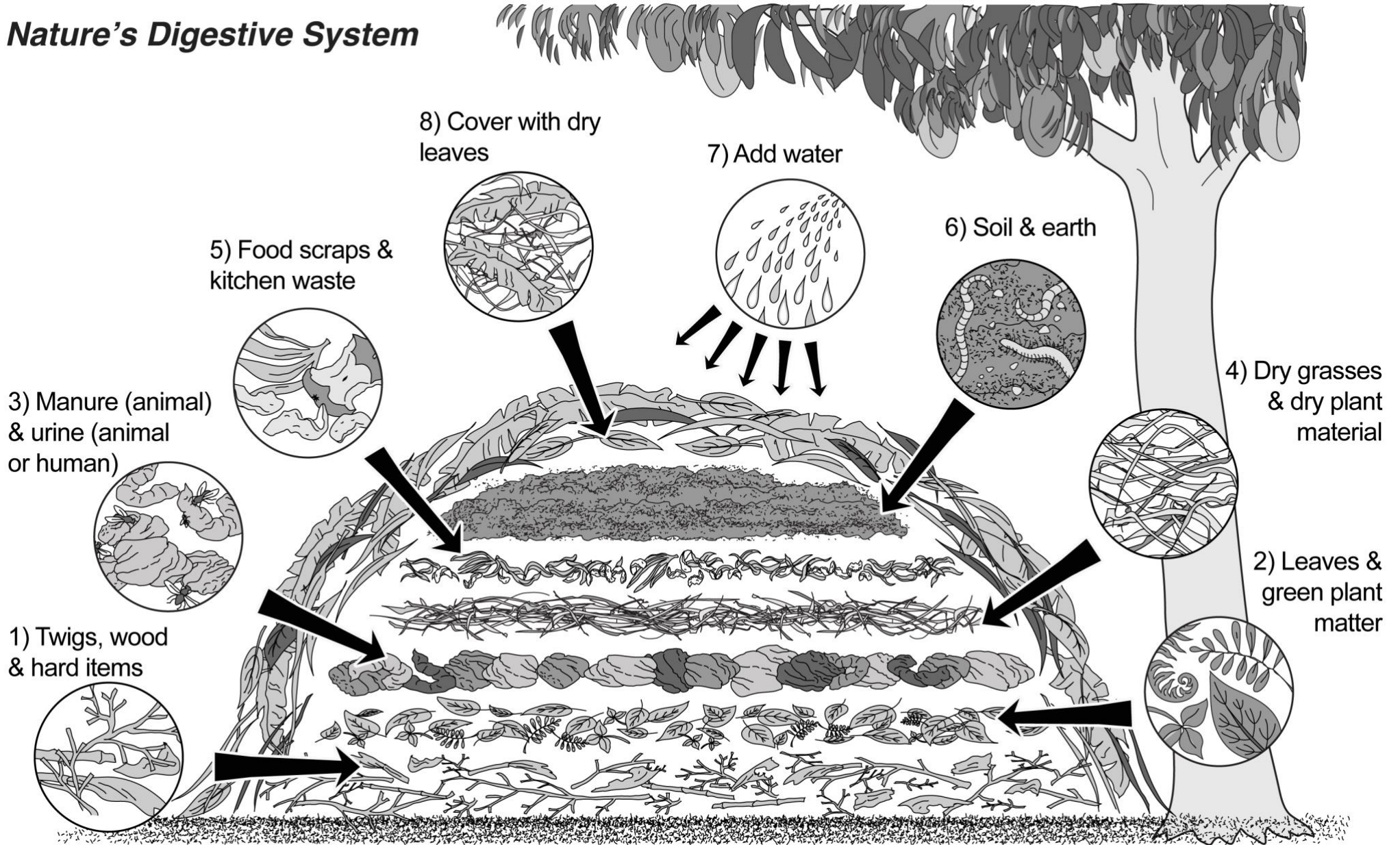

The Water Cycle

Poster 9

A Healthy Water Cycle needs a Healthy Environment

Healthy = Absorption

Rain falls on plants, trees and mulch
Water soaks in for plants to use
Fills water stores underground
Soil is not washed away
Plants and animals thrive

Unhealthy = Erosion

Rain falls on hard, bare soil
Water washes down hill taking soil away
Flooding and silting up of rivers down hill
Water table is not re-filled
Springs and wells dry up

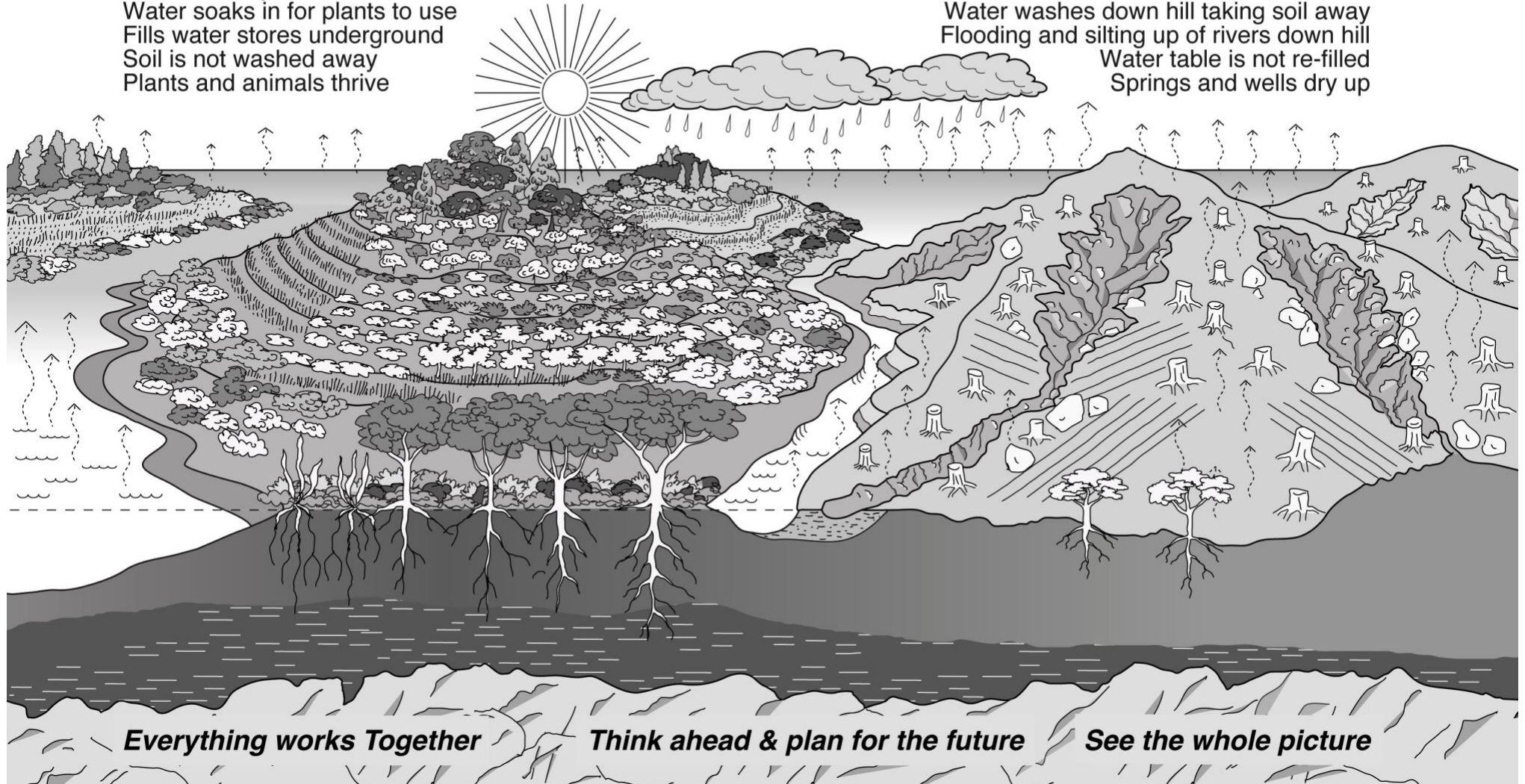

The Water Table

Poster 10

Healthy Water Table

Unhealthy Water Table

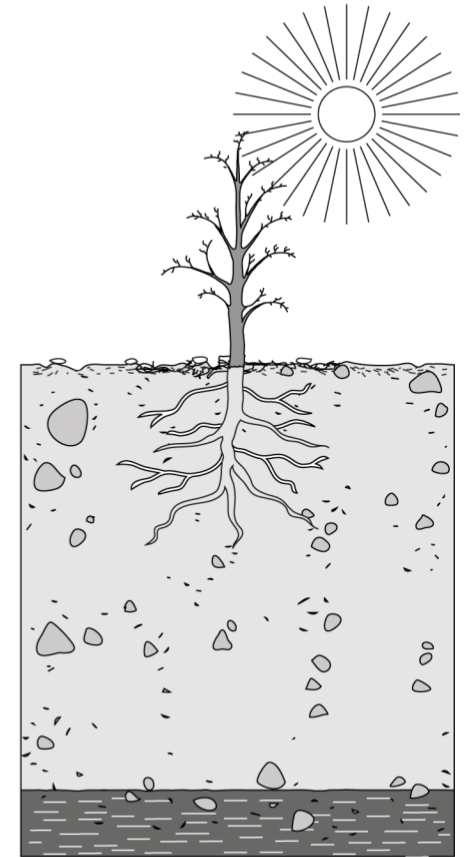
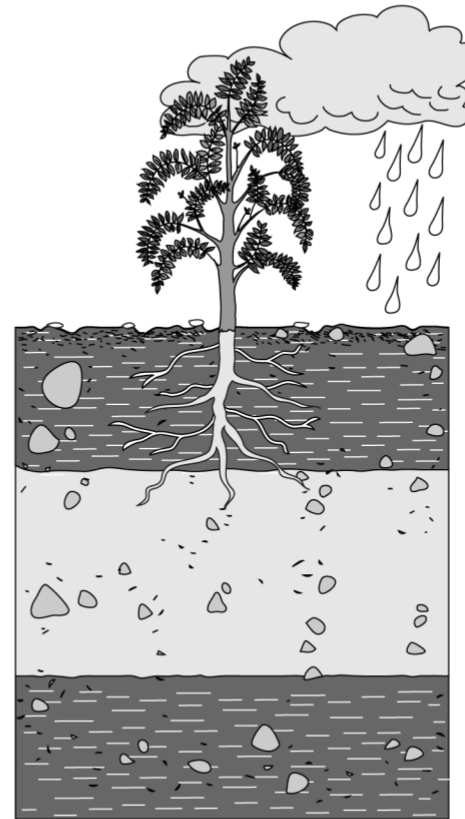
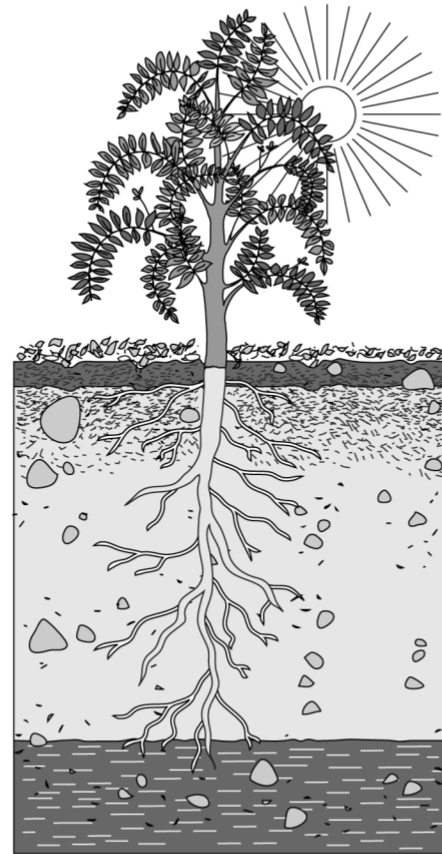
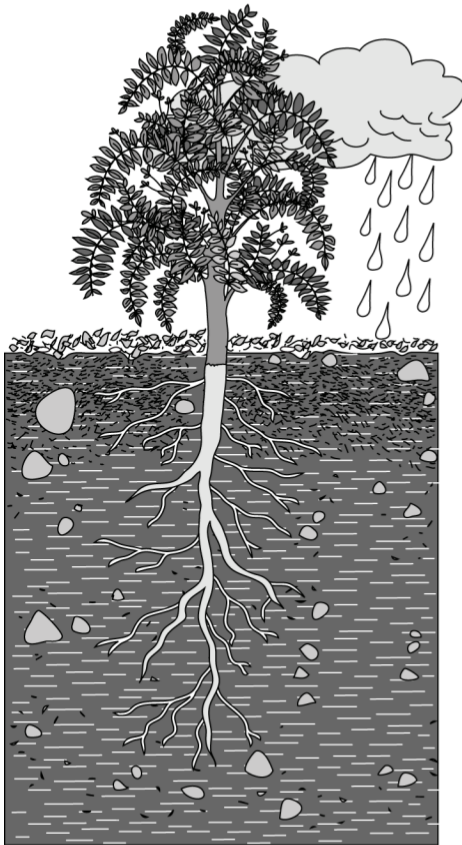

Rainy Season

Rains have soaked into healthy soil filling the water table. Roots can grow through soft soil which is protected by mulch.

Dry Season

The underground water stores are full. Deep-growing healthy roots can reach the water even during the dry season.

Rainy Season

Hard, bare soil does not let the water soak in. The roots can only absorb the water nearest to the surface.

Dry Season

The water table is low. The soil is too hard for the roots to grow through it. The plant is weak and vulnerable to drought.

Permaculture Zones

Poster 11

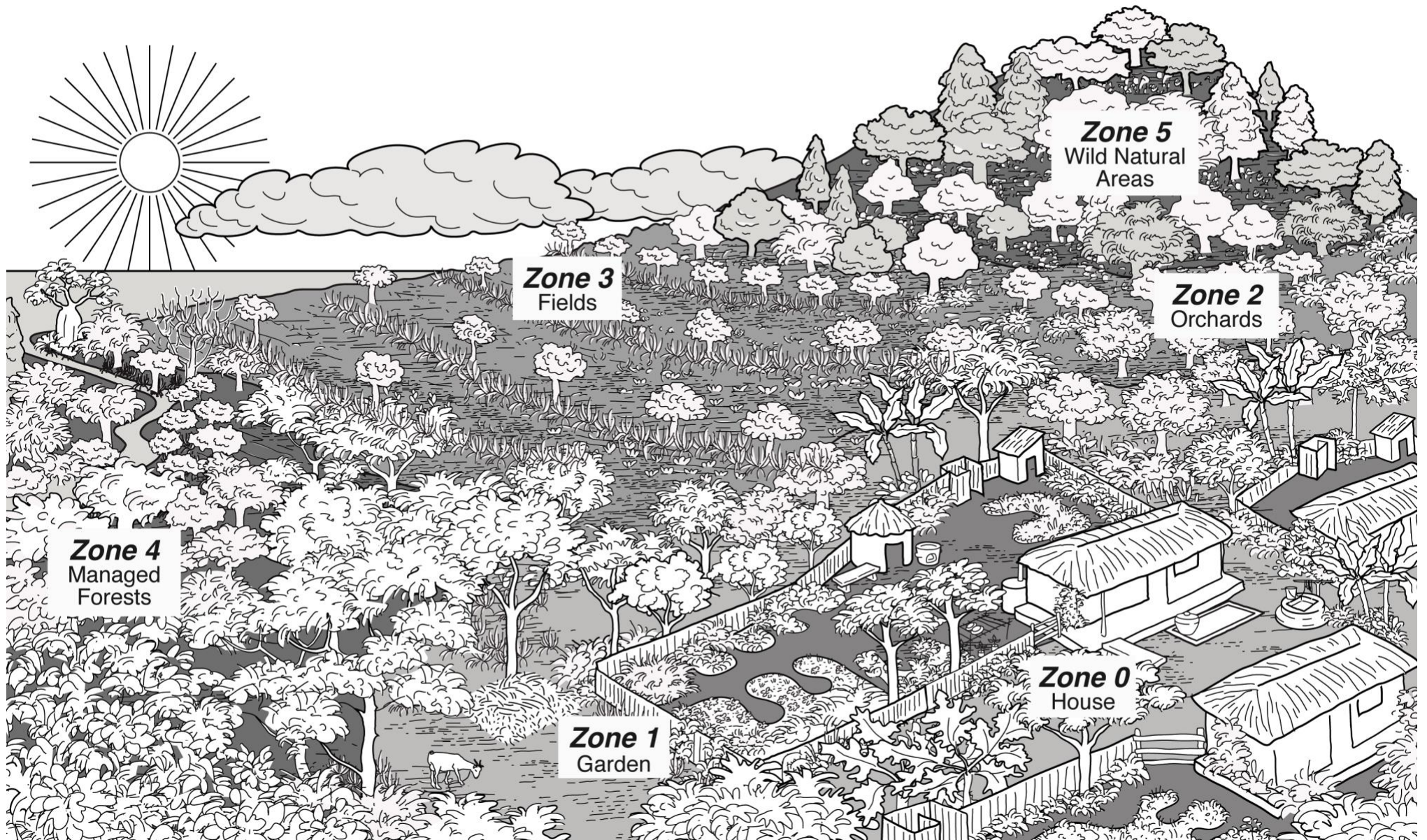

Zone 1 Garden

Poster 12

Intense production for things you use and care for every day.



Zone 1 might include:

- Zone 0 structures: House, kitchen, office, buildings, borehole, etc.
- Water conservation using drip irrigation and harvesting all water
- Energy conservation using fuel efficient stoves, solar cookers & dryers, etc.
- High maintenance annual plants and animals, scattered perennials
- Worm farm, compost, compost toilet and seed nurseries
- A hedgerow and / or fence if necessary for protection and privacy

Zone 2 Orchards

Poster 13

Integrated Orchards with things you use and care for weekly

Dry season



Zone 2 might include:

- Guilds of lower maintenance species of plants, trees and animals
- More perennials than in Zone 1
- Heavy mulch, few pathways, bee hives, ponds, compost piles
- Play areas and benches for relaxing and enjoying life

Rainy season



Zone 3 Fields

Poster 14

Integrated farming and harvests according to natural season

Dry season



Zone 3 might include:

- A mix of rain fed crops, animals and agroforestry either intercropped or in rotation.
- Windbreaks, compost and other soil, water and plant health practices
- Permanent pathways for access
- Heavy mulch in paths and between growing seasons
- Light mulch when small seeds are germinating

Rainy season



Zone 4 Managed Forests

Poster 15

Integrated forestry and harvests according to natural season

Dry season



Zone 4 might include:

- Mostly perennial species for fuel, medicines, building, fruits, nuts, oils, meats, etc.
- Naturally producing annuals ('wild' species)
- Large animal grazing, beehives, ponds, etc
- Beehives, ponds, etc.

Rainy season



Solar Cooker

Poster 16

See Part 1, Topic 12
Energy Use in the Kitchen
for full instructions

Thanks to
<http://solarcookers.org/basics/how.html>

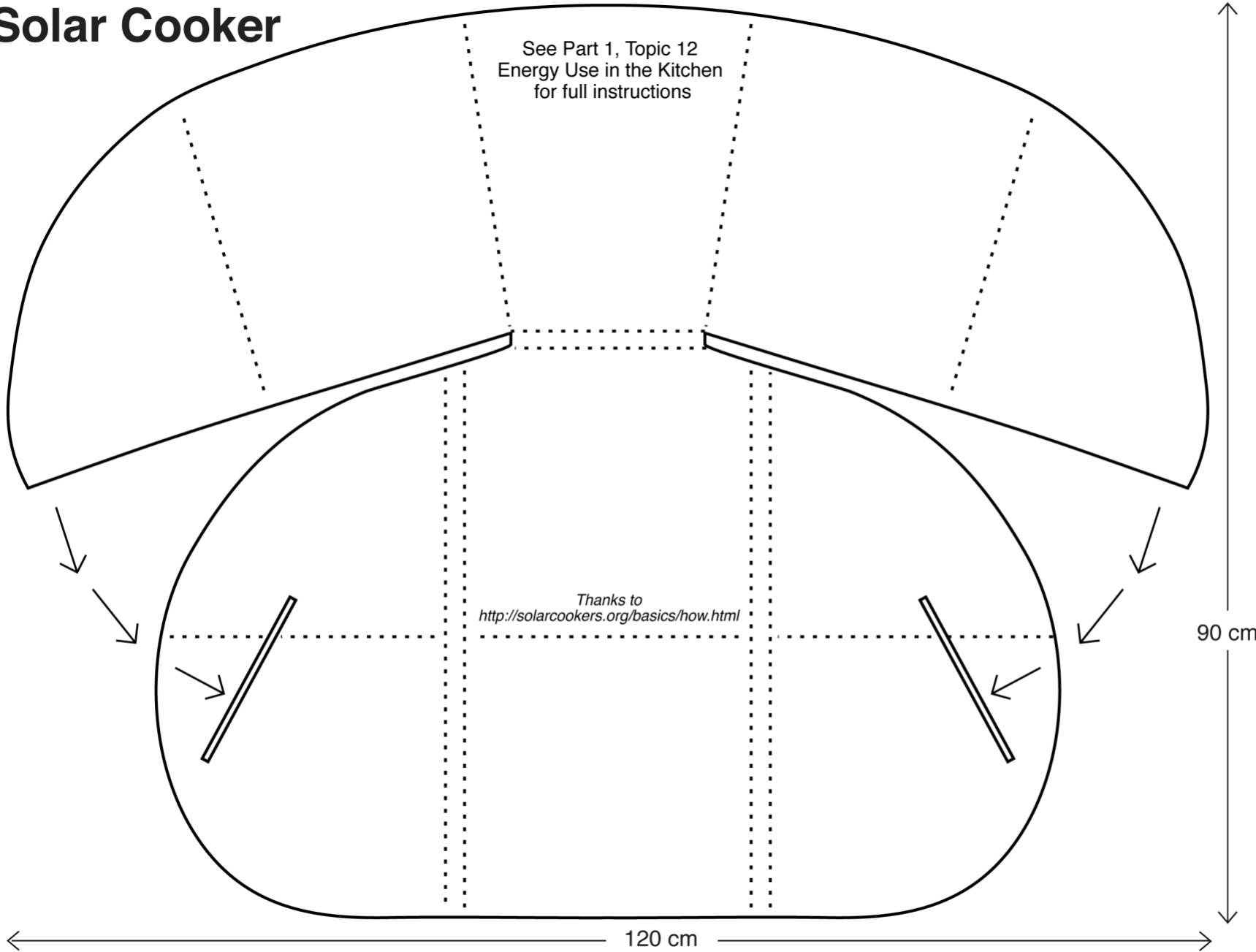

Glossary for Part 1

AIDS

Acquired Immunodeficiency Syndrome (a stage of HIV with many symptoms, 13)

Animal Food Group

Meat, eggs, milk, cheese etc. are animal foods, high in protein and minerals and help build the body, 16

Better Meal

Different food groups put together in a , better balance, with fewer staples than currently eaten in Malawi and more variety, 11

Bio-diversity

Variety of plants and animals (including trees, insects and micro-organisms) in the Natural World, 23

Bio-fuels

Plants and trees that are rich in oils that can be used for fuel, 77

Bio-gas

A flammable mixture of methane and carbon dioxide that is produced from the breakdown of organic matter, 76

Body Mass Index

A calculation that can indicate whether a person is a healthy weight for their height, or whether they are over-weight or under-weight, 35

Carbohydrates

The starchy or sugary nutrients in food that are fuel for energy, 5

Carnivores

Living things that eat meat, 2

Chemical Fertilisers

Fertilizer that has been artificially manufactured for plants, 7

Current meal

Unbalanced selection of food groups that doesn't have enough diversity to provide all the nutrients we need, 6

Cycle

Something that repeats itself in a circle. See also Nature Cycle and Water Cycle in Part 2 Healthy Environments, 7

Diet

The pattern of eating and drinking that an organism usually follows, 13

Digestion

The way the body processes foods and drinks so it can absorb the nutrients, 2

Environmental Degradation

Poor health and lack of diversity in the Natural World around us, 9

Enzymes

Juices in the stomach that help break down the food, 3

Fats

The nutrients that give our bodies stored energy, 5

Fats and Oils Food Group

Provides nutrients that give our bodies the most energy for the smallest quantity, 16

Fermenting

A process of carefully aging foods that often improves the nutrient value of the food, 48

Fibre

Part of plant food that is not digested but important in digestion and in keeping the intestines clean. It works together with water, 5

Filtered Water

Water that has passed through layers of rocks / sand / charcoal / cloth to remove impurities, 55

Food Groups

Similar types of foods grouped together according to the main nutrients in them, 15

Food security

When all people, at all times, have access to sufficient, safe and nutritious food, 7

Fruit Food Group

Provide vitamins that protect us from illness and infection and heal us when injured, but also provide more energy (from fruit sugars) than vegetables, 17

Fuel-efficient wood stoves

Stoves that make the best use of firewood for high energy and low smoke, 67

Germs

Micro-organisms that can give us illness and disease, 2

Herbivores

Living things that eat only plant foods, 2

Immune System

The system in our bodies that works to keep out diseases, fight off illnesses and heal us when we are sick, 12

Inputs

Something put into a system to achieve a result or output, may be purchased or free. Money and effort are inputs, so is time and the weather, 10

Insulated Basket Cookers

A way of cooking by holding the heat in a pot so it cooks without having to be on a stove all the time, 70

Intestines

Part of the long tube inside the body where most of the nutrients are absorbed into the body during digestion, 3

Legumes and Nuts Food Groups

Provides proteins and carbohydrates, also minerals and fibre. Legume plants have seeds in pods. These plants also fix nitrogen back into the soil, 16

Malnutrition

Poor nutrition due to a poor diet, or a problem with the digestion of nutrients, 6

Manure

Animal dung, compost, or other natural material that is used to fertilize the soil, 3

Micro-nutrients

Nutrients that are needed by the body in very small amounts, 18

Minerals

The nutrients in food that connect parts of our bodies together, found in different varieties and amounts in all the food groups, 5

Mono-cropping

To remove all diversity or variety from a natural system and plant only one or two types of crops, 8

Mono-diet

A diet which includes lots of one single kind of food and lacks diversity from all the food groups, 9

Nature Cycle

The Sustainable Natural System which recycles all living things endlessly, each thing providing nourishment for other things, 3

Ndiwo

A side dish in Malawi of greens, beans or meats served with a staple food, 6

Nsima

Maize meal made into a very thick porridge and served as the main staple food in Malawi, 6

Nutrient Dense

A food that is very high in nutrients compared to the calories the food provides, 44

Nutrients

The part of food that living things must have to live and thrive, 2

Nutrition Security

All people at all times have all the nutrients they need for a healthy active life. Nutrition security requires food security, water and healthy living conditions, 20

Oesophagus

The tube in the body that leads from the mouth to the stomach, 3

Omnivores

Living things that eat animal and plant foods, 2

Organic Matter

Natural material from plants or animals, like leaves, wood, bones, skin, hair, feathers, leather etc., 76

Paper Charcoal Briquettes

Made from waste paper for burning instead of burning wood or charcoal, 68

Parabolic

The curved shapes of some designs of solar cookers, 73

Protein

The nutrient that our bodies are built from, found in Legumes & Nuts, Animal foods and some vegetables and grains, 5

Pyramid of Nutrition Needs

Nutrition relies on a base of healthy natural systems building up to healthy human system, food and water security and healthy living conditions, vii

Recycle

To use something again, often in a new way, 46

Resource

Anything that can be used productively. Raw materials are resources and may be sustainable or non sustainable (See Part 2 Topic 15). Food, water and air are resources So are energy, time and creativity, viii

Root Cellar

Cool under-ground storage for keeping root crops, 53

Solar Cookers

Stoves designed to cook food or heat water by trapping the heat of the sun, 71

Staple

Staple foods are the largest part of the diet and provide carbohydrates for energy. A staple crop is the main crop, 6

Staple Food Group

Bulky foods that fill you up and provide fuel for energy, 17

Sustainable

Something that can carry on, that can continue, that will not run out or wear out. See Topic 15 Sustainable Systems in Part 2 of the Manual, vi

Sustainable Nutrition

Food, water and health security, for ever, vi

Tippy-tap

A container that is hung so that it can easily tip to release water for washing hands, 51

Vegetable Food Group

Provide vitamins that protect us from illness and infection and heal us when injured, 17

Vegetarians

Humans that eat no meat, only plant foods. (Some vegetarians do eat fish, eggs or milk but not meat), 2

Vitamins

The nutrients in food that protect us from illness and infection and heal us when injured, found mostly in Vegetable and Fruits Food Groups, 5

Water

Water is a vital nutrient that helps to keep the intestines clean, removes harmful substances from the body, and is used in sustaining all life, 5

Whole Grain

Grains which still have the germ and the bran, usually usually keeping a brown or dark colour. Brown flours are more nutritious than white flours, 17

Sustainable Nutrition Manual

Food, Water, Agriculture & Environment

This manual is for people who eat, grow or buy food and who want to improve their lives, their community and the environment that they live in. It has been written for, and by, people living in Malawi. It will show you how to eat and live better and guide you in designing a sustainable future.

The manual aims to show that by thinking differently and thinking sustainably you can improve your health, diet, lifestyle and surroundings easily and cheaply and gain an understanding of the term Sustainable Nutrition.

Use the ideas in this manual and you will be able to:

- Improve your diet and health
- Save money that was spent on food, medicines and chemicals
- Double or triple yields and harvests (or even more!)
- Reduce the amount of watering in your gardens and orchards
- Reduce the amount of work done on your land and in your home
- Have healthier plants and animals
- Reduce infertile and unproductive areas of land
- Use free resources to improve soil and water in your area

Part 1 - Healthy Humans is about the human body and nutrition. You will also learn about food choices and the benefits of diversity in diet. It has lots of useful ideas to improve life and many delicious recipes and suggestions for tasty, healthy meals.

Part 2 - Healthy Environments is about natural systems and sustainability. You will learn about the Nature Cycle and the Water Cycle and natural sustainable systems. You will be introduced to Permaculture ideas and gain an understanding of the benefits of diversity in Nature.

Part 3 - Healthy Designs is about designing for sustainable living. This book brings parts 1 and 2 together and guides you to make a personalised plan for Sustainable Nutrition. This book is a practical one to use to design everything on your land. There is lots of information in the appendices about foods of Malawi and other resources that will be useful as your design develops.

Nordin, Stacia. *Sustainable Nutrition Manual: Food, Water, Agriculture & Environment*.
2nd ed. Ed. Sarah Beare. Lilongwe: World Food Programme Malawi, 2016.

First published by World Food Programme (WFP) Malawi as:
Low Input Food and Nutrition Security: Growing and Eating More for Less (2005)